

**SULZER**

## Original instructions

**Installation, operation and maintenance instructions**  
Submersible Pump Type ABS XFP PE4 - PE6, AFLX PE3  
- PE6, VUPX PE3 - PE6





## Table of contents













<b>1. Important notice</b> .....	<b>4</b>
<b>2. Symbols and notices</b> .....	<b>4</b>
<b>3. General</b> .....	<b>5</b>
3.1. Hydraulics - XFP / AFLX / VUPX.....	5
3.2. Intended use and application.....	5
3.2.1. Application areas.....	6
3.3. Operation of Ex submersible units in wet-well installation without cooling jacket .....	7
<b>4. Performance range</b> .....	<b>7</b>
<b>5. Safety</b> .....	<b>8</b>
5.1. Personal protective equipment.....	8
<b>6. Use of motors in Ex zones</b> .....	<b>8</b>
6.1. Explosion-proof approvals.....	8
6.2. General information.....	9
6.3. Special conditions for safe use.....	9
6.4. Operation of Ex submersible units with variable frequency drive (VFD).....	9
<b>7. Technical data</b> .....	<b>10</b>
7.1. Cables.....	10
7.2. Nameplates.....	11
7.2.1. Nameplate drawings.....	11
<b>8. Lifting, transport and storage</b> .....	<b>13</b>
8.1. Lifting.....	13
8.1.1. Vertical and horizontal lifting.....	13
8.2. Transport.....	14
8.3. Storage.....	15
8.3.1. Moisture protection of motor connection cable.....	15
<b>9. Setup and installation</b> .....	<b>15</b>
9.1. Equipotential bonding.....	16
9.2. Installation - XFP.....	16
9.2.1. Wet well installation.....	17
9.2.2. Dry installation.....	19
9.2.3. Fitting of pedestal bracket o-ring and guide piece.....	19
9.2.4. Tightening torque.....	20
9.2.5. Fitting position of the Nord-Lock <sup>®</sup> securing washers.....	20
9.3. Installation - AFLX / VUPX.....	21
9.3.1. Lowering of the AFLX and VUPX submersible pump into the coupling ring.....	22
9.3.2. Bar spacing.....	23
<b>10. Electrical connection</b> .....	<b>24</b>
10.1. Seal monitoring.....	25
10.3. Temperature monitoring - Stator.....	26
10.4. Temperature monitoring - Bearings (Optional).....	26
10.5. Temperature sensor.....	26
10.5.1. Temperature sensor bimetal.....	27
10.5.2. Temperature sensor PTC.....	28
10.5.3. Temperature sensor PT 100.....	28
10.6. Operation with variable frequency drive (VFD).....	29

Table of contents	Page 3
10.7. Wiring diagrams.....	29
10.7.1. Lead designations.....	31
10.8. Monitoring options.....	31
10.9. Connection of the control circuit leads.....	32
10.10. Connecting the EMC cable in the control cabinet.....	33
<b>11. Commissioning.....</b>	<b>33</b>
11.1. Direction of rotation.....	34
11.1.1. Checking direction of rotation.....	34
11.1.2. Changing direction of rotation.....	35
<b>12. Maintenance and service.....</b>	<b>35</b>
12.1. General maintenance instructions.....	36
12.2. Inspection intervals.....	36
12.3. Lubricants.....	36
12.3.1. Lubricant changing - XFP with cooling jacket.....	37
12.3.2. Lubricant changing - XFP / AFLX / VUPX without cooling jacket.....	39
12.3.3. Oil and coolant quantities.....	44
12.3.4. Reference values for anti-freeze behaviour.....	48
12.4. Starting frequency of the motors.....	48
12.5. Removal.....	49
12.5.1. Removal of the XFP submersible sewage pump from a wet sump.....	49
12.5.2. Removal of th XFP submersible sewage pump when dry-installed.....	49
12.5.3. Removal of the AFLX and VUPX submersible pump.....	50
<b>13. Company details.....</b>	<b>50</b>

## 1. Important notice

	<b>NOTE</b>
	The original version of this document is in English. All other languages are a translation of the original. In case of a discrepancy, the English version will prevail.
	<b>NOTE</b>
	The layout and wording of the online version of this manual may vary from the printed version. The same information is provided in both.

## 2. Symbols and notices

	 <b>DANGER</b>
	Presence of dangerous voltage
	 <b>DANGER</b>
	Danger of an explosion occurring.
	 <b>WARNING</b>
	Hot surface - danger of burn or injury.
	 <b>WARNING</b>
	Hot liquid - danger of burn or injury.
	 <b>CAUTION</b>
	Non-compliance may result in personal injury.
	<b>ATTENTION</b>
	Non-observance may result in damage to the unit or negatively affect its performance.
	<b>NOTE</b>
	Important information for particular attention.

### 3. General

<b>!</b>	<b>NOTE</b>
	Sulzer reserves the right to alter specifications due to technical developments.

### 3.1. Hydraulics - XFP / AFLX / VUPX

Table 1.

Submersible sewage pump type ABS:								
XFP CB								
105J	150M	205J	250J	305J	356M	405M		
106J	151M	206J	255J	305M				
107J	155J	205M		306M				
XFP CH; SK								
100J	150J	200J	250M	300J	351M	400M	500U	600V
		200M		300M		400R	501U	600X
				301M				

Submersible mixed flow column pump type ABS:			
AFLX			
0601	0701	0801	1202
		0803	1203
			1207

Submersible propeller pump type ABS:					
VUPX					
0402	0501	0601	0801	1001	1201
0403	0502	0602	0802	1002	1202
	0503				

### 3.2. Intended use and application

In the case of any faults arising, the Sulzer units should immediately be taken out of use and secured. The fault should be immediately rectified, or if necessary, contact your Sulzer Service Centre.





Temperature limiter in the winding = 140 °C / 284 °F (bimetallic or thermistor [PTC] as an option).

#### Special version Class H

A special version with temperature limiter in the winding = 160 °C/320 °F (bimetallic, temperature sensor [PTC] as an option or PT100) is also available. This version is only available without explosion-proof or NEC 500 approval with isolation class H (160) components.

For both versions an EMC execution is available as an option.

These units must not be used in certain applications e.g. operating within flammable, combustible, chemical, corrosive, or explosive liquids.

	<b>ATTENTION</b>
	The maximum immersion depth is 20 m / 65 ft.
	<b>ATTENTION</b>
	The maximum allowable temperature of the medium pumped is 40 °C / 104 °F.
	<b>ATTENTION</b>
	Leakage of lubricants could result in pollution of the medium being pumped.
	<b>ATTENTION</b>
	Always consult with your local Sulzer representative for advice on approved use and application before installing the unit.

### 3.2.1. Application areas

#### 3.2.1.1. Submersible Sewage Pump Type ABS XFP

The submersible sewage pumps type ABS XFP series have been designed for the economical and reliable pumping of commercial, industrial and municipal sewage and can be installed dry or wet. They are suitable for pumping of the following liquids:

- Clean and wastewater.
- Sewage containing solids and fibrous material.
- Faecal matter
- Sludge.
- Fresh and process water pumping.
- Raw water for drinking water supply.
- Surface and rain water.
- Sewage.

#### 3.2.1.2. Submersible Mixed Flow Column Pump Type ABS AFLX

The mixed flow column pump type ABS AFLX series have been developed for environmental protection, water supply, municipal sewage treatment and dewatering of polders. They are suitable for the following liquids:

- Storm water protection, irrigation and aquaculture.
- Industrial raw water and process water.
- Combined sewage and surface water.
- Recirculation sludge or return activated sludge (RAS).
- Hazardous locations: Certification for ATEX (Ex II 2G Ex h db IIB T4 Gb), FM and CSA available as an option.

4. Performance range

The AFLX pumps are installed in a concrete sump or in a steel pressure pipe using a suitable coupling ring. A screen must be attached to the inlet.

**Related concepts**

[Installation - AFLX / VUPX](#) on page 21

**3.2.1.3. Submersible Propeller Pump Type ABS VUPX**

The submersible propeller pumps type ABS VUPX series are designed for those applications where large water volumes must be pumped at low heads (up to 10 m / 33 ft). They are suitable for the following liquids:

- Storm water protection, irrigation and aquaculture.
- Industrial raw water and process water.
- Combined sewage and surface water.
- Recirculation sludge or return activated sludge (RAS).
- Hazardous locations: Certification for ATEX (Ex II 2G Ex h db IIB T4 Gb), FM and CSA available as an option.

The VUPX pumps are installed in a concrete sump or in a steel pressure pipe using a suitable coupling ring. A screen must be attached to the inlet.

**Related concepts**

[Installation - AFLX / VUPX](#) on page 21

**3.3. Operation of Ex submersible units in wet-well installation without cooling jacket**

It must be ensured that the top of the motor housing of the Ex submersible unit is fully submerged during start-up and operation for self cooling.

**4. Performance range**

**Figure 1. XFP 50 Hz / 60 Hz**

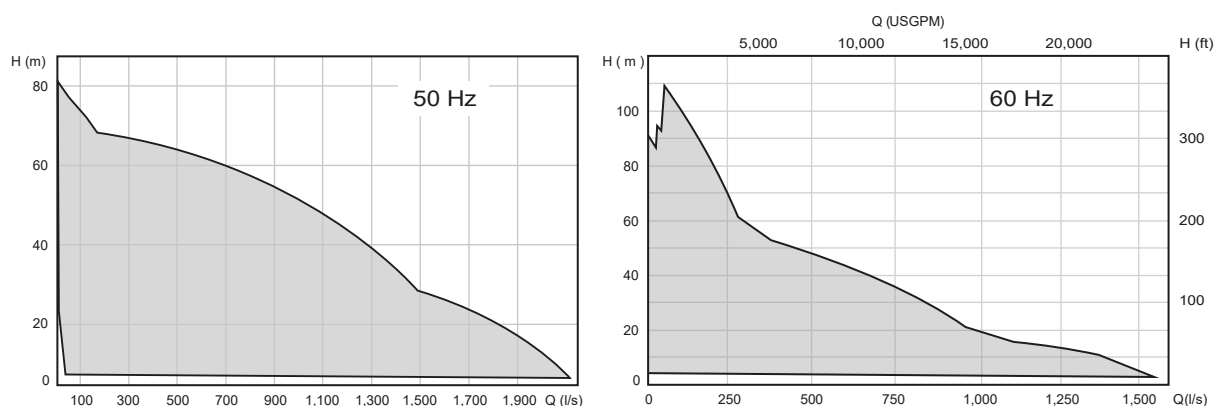

**Figure 2. AFLX**

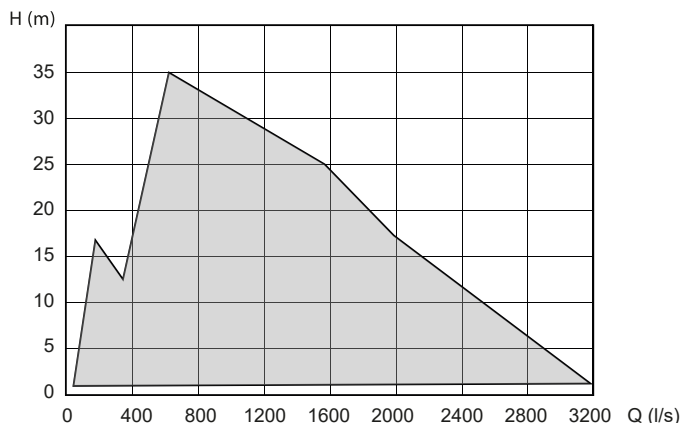

**Figure 3. VUPX**

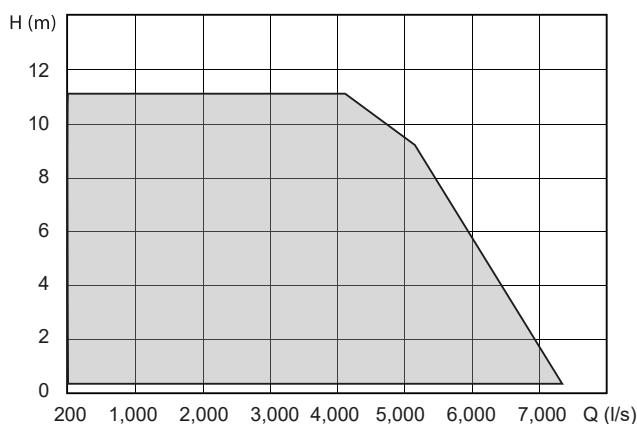

## 5. Safety

The general and specific health and safety guidelines are described in detail in the "Safety Instructions for Sulzer Products Type ABS" booklet. If anything is not clear or you have any questions as to safety make certain to contact the manufacturer Sulzer.

### 5.1. Personal protective equipment

Submersible electrical units can present mechanical, electrical, and biological hazards to personnel during installation, operation, and service. It is obligatory that appropriate personal protective equipment (PPE) is used. The minimum requirement is the wearing of safety glasses, footwear, and gloves. However, an on-site risk assessment should always be carried out to determine if additional equipment is required e.g. safety harness, breathing equipment etc.

## 6. Use of motors in Ex zones

### 6.1. Explosion-proof approvals



The submersible pumps with PE motor can be supplied both as standard versions and in explosion-proof execution with Ex II 2G Ex h db IIB T4 Gb for 50 Hz according to the standards EN ISO 12100:2010, EN 809:1998 + A1:2009 + AC:2010, EN



60079-0:2012+A11:2018, EN 60079-1:2014, EN 60034-1:2010, EN ISO80079-36, EN ISO 80079-37, or FM execution (NEC 500, Class I, Division 1, Group C&D, T3C) for 60 Hz in isolation class H (140).

	<b>NOTE</b>
	In explosion protection method type "c" (constructional safety) and type "k" (liquid immersion) in accordance with EN ISO 80079-36, EN ISO 80079-37 are used.

## 6.2. General information

	 <b>DANGER</b>
	<p><b>Danger of explosion</b></p> <p>In hazardous areas care must be taken that during switching on and operation of the unit, the hydraulic section is filled with water (dry installation) or alternatively is submerged (wet well installation).</p>

Other types of operation e.g. snore operation or dry running are not allowed!

1. Explosion-proof submersible units may only be operated with the thermal sensing system connected.
2. Temperature monitoring of explosion-proof submersible units must be carried out by bi-metallic temperature limiters or thermistors according to DIN 44 082 connected to a suitable release device which is certified in accordance with EC directive 2014/34/EU and FM 3610.
3. Float switches, and any external seal monitoring (leakage sensor (DI), must be connected via an intrinsically safe electrical circuit, Protection Type EX (i), in accordance with IEC 60079-11 and FM 3610.
4. In the event that the unit is to be operated in explosive atmospheres using a variable speed drive (VFD), please contact your local Sulzer representative for technical advice regarding the various approvals and standards concerning thermal overload protection.

	<b>ATTENTION</b>
	Some units are approved for use in hazardous locations, and are fitted with a nameplate containing technical data and Ex certification. Repair work on Ex rated units must be carried out in Ex approved workshops by qualified personnel, using original parts supplied by the manufacturer. Otherwise it must no longer be used in hazardous locations, and where fitted, the Ex nameplate must be removed and replaced by a standard version.

	<b>NOTE</b>
	All local regulations and guidelines must be followed without exception.

## 6.3. Special conditions for safe use

Repairs on flameproof joints may only be performed in accordance with the manufacturer's design specifications. Repair on the basis of the values in tables 2 and 3 of EN 60079-1 or annex B and D of FM 3615 is not permitted.

## 6.4. Operation of Ex submersible units with variable frequency drive (VFD)

Motors must have direct thermal protection devices fitted. These consist of temperature sensors (PTC DIN 44082) embedded in the windings. These must be connected to a suitable release device which is certified in accordance with EC directive 2014/34/EU.

Machines designated as Ex must never, without exception, be operated using a mains frequency that is greater than the maximum 50 Hz or 60 Hz as indicated on the nameplate.

## 7. Technical data

Maximum noise level  $\leq 70$  dB. In some types of installations it is possible that during operation the noise level of 70 dB(A) or the measured noise level may be exceeded.

Detailed technical information is available in the technical data sheet which can be downloaded from <https://www.sulzer.com>

### 7.1. Cables

The weights in the dimension sheets refer to a cable length of 10 m. In the case of cable lengths exceeding 10 m the additional weight must be determined and added using the following table.

**Table 2.**

Cable type	Weight (kg/m)	Cable type	Weight (kg/m)	Cable type	Weight (kg/m)	Weight (lb/1000ft)
<b>EMC-FC / S1BC4N8-F</b>		<b>S1BN8-F / H07RN8-F / 07BN8-F</b>		<b>G-GC</b>		
3x6/6KON	0.4	2 x 4 G 4 + 2 x 0,75	0.6	AWG 8-3	0.9	597
3x10/10KON	0.7	4 G 4	0.5	AWG 6-3	1.2	764
3x16/16KON	1	4 G 6	0.5	AWG 4-3	1.6	1070
3x6/6KON +3x1,5ST	0.6	4 G 10	0.8	AWG 2-3	2.3	1533
3x25 +3G16/3	1.5	4 G 16	1.3	AWG 1-3	2.8	1865
3x35 +3G16/3	1.9	4 G 25	1.8	AWG 1/0-3	3.5	2315
3x50 +3G25/3	2.6	4 G 35	2.3	AWG 2/0-3	4.1	2750
3x70 +3G35/3	3.6	4 G 50	3.0	AWG 3/0-3	5	3330
3x95 +3G50/3	4.7	4 G 70	4.2	AWG 4/0-3	6.1	4095
3x120 + 3G70/3	6	4 G 95	5.5	<b>Type W</b>		
3x150 + 3G70/3	7.1	4 G 120	6.7	AWG 1/0	0.7	480
3x185 +3G95/3	8.8	7 G 1,5	0.5	AWG 2/0	0.8	558
3x240 +3G120/3	11	10 G 2,5	0.8	AWG 3/0	1.1	742
3x300 +3G150/3	13.5	4 G 1,5	0.2	AWG 4/0	1.3	872
1x185	2.2	8 G 1,5	0.4	250 MCM	1.7	1170
1x240	2.7	10 G 1,5	0.5	300 MCM	1.9	1308
1x300	3.4	12 G 1,5	0.5	350 MCM	2.3	1530
		1x150	1.8	400 MCM	2.5	1670
		1x185	2.2	500 MCM	3.1	2090
		1x300	3.4	646 MCM	3.6	2416
		1x400	4.1	<b>SOOW</b>		

*table continued*

Cable type	Weight (kg/m)	Cable type	Weight (kg/m)	Cable type	Weight (kg/m)	Weight (lb/1000ft)
				AWG 16/4	0.3	144
				AWG 16/8	0.4	222
				AWG 16/10	0.5	278
				AWG 16/12	0.5	305

## 7.2. Nameplates

Some units are approved for use in hazardous locations, and are fitted with a nameplate containing technical data and Ex certification. Repair work on Ex rated units must be carried out in Ex approved workshops by qualified personnel, using original parts supplied by the manufacturer. Otherwise it must no longer be used in hazardous locations, and where fitted, the Ex nameplate must be removed and replaced by a standard version.

We recommend that you record the data from the standard nameplate on the unit in the legend below, and maintain it as a source of reference for the ordering of spare parts, repeat orders and general queries.

Always state the type, item number and serial number in all communications.

### 7.2.1. Nameplate drawings

Figure 4. Standard nameplate

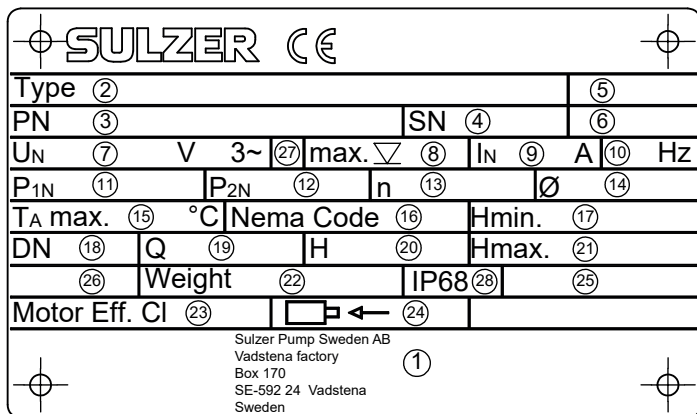

Table 3. Legend, 50 Hz / 60 Hz

Legend	Description	Data
1	Address	
2. Type	Pump type	
3. PN	Item No.	
4. SN	Serial No.	
5.	Order number	
6. xx/xxxx	Production date (Week/Year)	

table continued

Legend	Description	Data
7. $U_N$	Rated voltage	V 3~
8. $\Sigma_{max}$ .	Maximum submergence depth	m / ft
9. $I_N$	Rated current	A
10. Hz	Frequency	Hz
11. $P_{1N}$	Power (consumption)	kW / hp
12. $P_{2N}$	Power (output)	kW / hp
13. n	Speed	r/min / RPM
14. $\emptyset$	Impeller / propeller diameter	mm / ins
15. $T_A_{max}$ .	Max. ambient temperature	
16. NEMA	NEMA code	Class
17. Hmin	Minimum head	m / ft
18. DN	Discharge diameter	mm / ins
19. Q	Pumping quantity	
20. H	Pumping height	
21. Hmax	Maximum head	m / ft
22. Weight	Weight without attached parts	kg / lbs
23. Motor Eff. Cl	Motor efficiency class	
24. 	Motor shaft direction of rotation	
25.	Continuous operating mode	
26.	Sound level	
27.	Phase connection	
28. IP68	Protection method	

Figure 5. Ex nameplates



- 1 ATEX nameplate
- 2 CSA nameplate
- 3 FM nameplate

## 8. Lifting, transport and storage

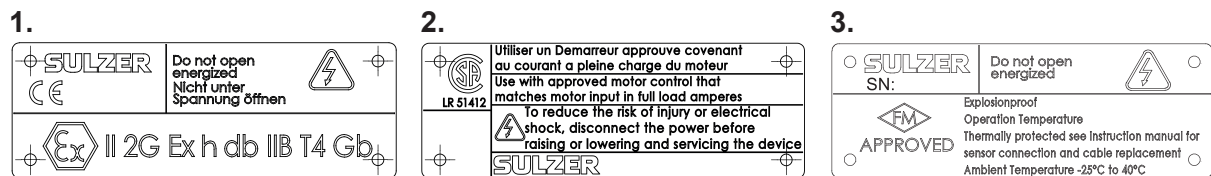
### 8.1. Lifting

	<b>ATTENTION</b>
	<b>Observe the total weight of the Sulzer units and their attached components! (see nameplate for weight of base unit).</b>

The duplicate nameplate provided must always be located and visible close to where the unit is installed (e.g. at the terminal boxes / control panel where the cables are connected).

	<b>NOTE</b>
	<b>Lifting equipment must be used if the total unit weight and attached accessories exceeds local manual lifting safety regulations.</b>

The total weight of the unit and accessories must be observed when specifying the safe working load of any lifting equipment! The lifting equipment, e.g. crane and chains, must have adequate lifting capacity. The hoist must be adequately dimensioned for the total weight of the Sulzer units (including lifting chains or steel ropes, and all accessories which may be attached). The end user assumes sole responsibility that lifting equipment is certified, in good condition, and inspected regularly by a competent person at intervals in accordance with local regulations. Worn or damaged lifting equipment must not be used and must be properly disposed of. Lifting equipment must also comply with the local safety rules and regulations

	<b>NOTE</b>
	<b>The guidelines for the safe use of chains, ropes and shackles supplied by Sulzer are outlined in the Lifting Equipment manual provided with the items and must be fully adhered to.</b>

#### 8.1.1. Vertical and horizontal lifting

	 <b>DANGER</b>
	<b>Dangerous voltage</b> The pump must be raised only by the lifting hoop and never by the power cable.

Depending on model and mode of installation, the units are prepared at the factory for vertical or horizontal transportation.

The units are equipped with a safety shackle (series for vertical setup) or swivel ring bolt (horizontal setup), which allow fixing chains for transporting or for installing or removing. We recommend using chains from the Sulzer list of accessories.

	 <b>CAUTION</b>
	Take note of the entire weight of the unit (see nameplate). The hoist and chain must be adequately dimensioned for the weight of the unit and must comply with the current valid safety regulations.

	<b>ATTENTION</b>
	In the case of pumps set up vertically, sealing plugs are mounted for protecting the thread holes instead of swivel ring bolts. These seals may only be replaced by a swivel ring bolt for maintenance work but must be screwed on again before startup!

**Figure 6. Horizontal transport**

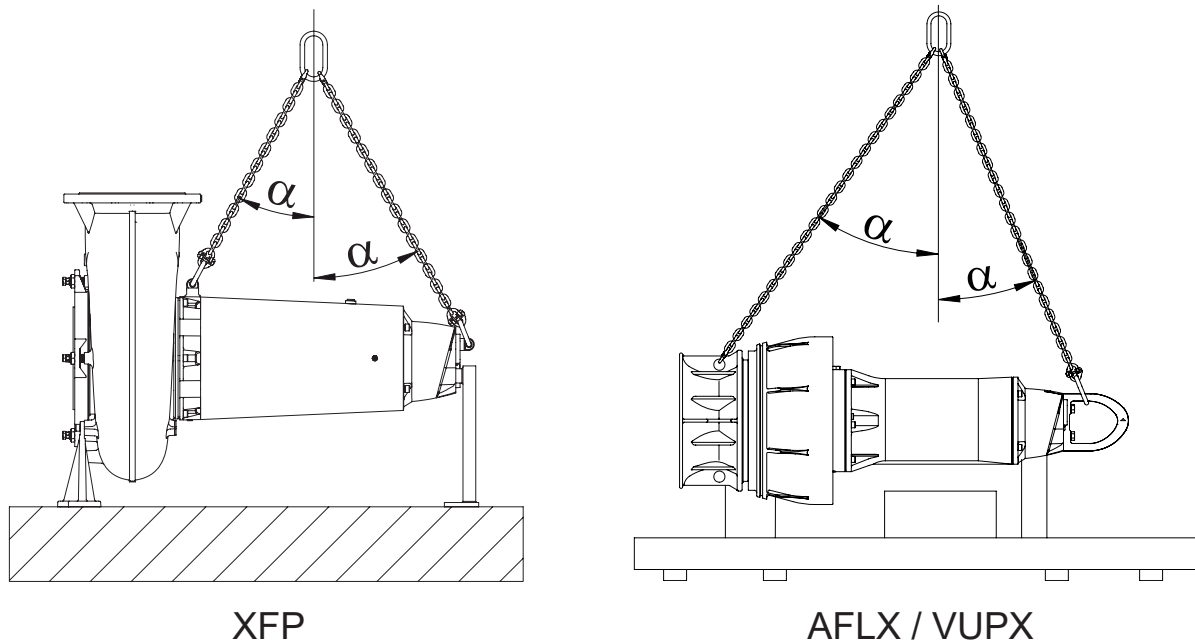

	<b>ATTENTION</b>
	α max. ≤ 45°. The angle α between the centre line of the unit and the lifting tools should not exceed 45°.

**Related concepts**

[Nameplate drawings](#) on page 11

## 8.2. Transport

During transport, care should be taken that the pump cannot fall over or roll and cause damage to the pump or injury to the person. The pumps have a lifting hoop for lifting or suspension of the pump.

	<b>CAUTION</b>
	After removal from its original packaging we recommend that during future transportation of the pump it is laid on its side and securely strapped to a pallet.

In order to avoid damage to the pump shaft or the bearings during horizontal transport the shaft is clamped in an axial direction when leaving the works.

	<b>ATTENTION</b>
	The motor shaft transport lock must be removed before startup!

## 8.3. Storage

	<b>ATTENTION</b>
	The Sulzer products must be protected from weather influences such as UV from direct sunlight, high humidity, aggressive dust emissions, mechanical damage, frost etc. The Sulzer original packaging with the relevant transport securing devices (where used) ensures optimum protection of the unit. If the units are exposed to temperatures under 0 °C / 32 °F check that there is no water in the hydraulics, cooling system, or other spaces. In the case of heavy frosts, the units and cable should not be moved if possible. When storing under extreme conditions, e.g. in tropical or desert conditions suitable additional protective steps should be taken. We would be glad to advise you further

	<b>NOTE</b>
	The Sulzer units normally require no maintenance during storage. During longer storage times, (after approx. one year) the transport locks on the motor shaft (not all versions) must be dismantled. Coolant is applied to the sealing surfaces by manually turning the shaft several times (also for the purpose of cooling or lubricating so that trouble-free function of the sliding ring seal is ensured). No maintenance is required when storing the motor shaft.

### 8.3.1. Moisture protection of motor connection cable

The motor connection cables are protected against the ingress of moisture along the cable by having the ends sealed at the factory with protective covers.

	<b>ATTENTION</b>
	<b>The ends of the cables should never be immersed in water as the protective covers only provide protection against water spray or similar (IP44) and are not a water tight seal. The covers should only be removed immediately prior to connecting the units electrically.</b>

During storage or installation, prior to the laying and connection of the power cable, particular attention should be given to the prevention of water damage in locations which could flood.



	<b>ATTENTION</b>
	<b>If there is a possibility of water ingress then the cable should be secured so that the end is above the maximum possible flood level. Take care not to damage the cable or its insulation when doing this.</b>

## 9. Setup and installation

The wires (motor cable) are designed according to EN 50525-1, the operating conditions are based on table 14 for special rubber cables. The load capacity of the wires is adapted to an ambient temperature of 40°C according to table 15 (column 4 for multicore cables and column 5 for single-core cables), and calculated with a factor for clustering and installation type. A minimum gap of 1x outer diameter of the cable used applies when installing.

	<b>ATTENTION</b>
	Twisting must not occur. The cables must not touch anything, not grabbed or bundled. When extending, recalculate the wire cross-section according to EN 50525-1, irrespective of the cable and installation type, cluster etc.!

## 9.1. Equipotential bonding

	 <b>DANGER</b>
	<p><b>Dangerous voltage</b></p> <p>In pump stations/tanks, equipotential bonding must be carried out according to EN60079-14:2014 [Ex] or IEC 60364-5-54 [non-Ex] (Regulations for the installation of pipelines, protective measures in high voltage systems).</p>

## 9.2. Installation - XFP

There are three main installation options for the submersible pumps.

1. Wet well installation (vertical) with Sulzer automatic coupling system.
2. Dry installation with ground support ring and closed cooling system.
3. Dry installation (horizontal) with closed cooling system.



## 9.2.1. Wet well installation

### About this task

**Figure 7. Wet installation (vertical) with Sulzer automatic coupling system**

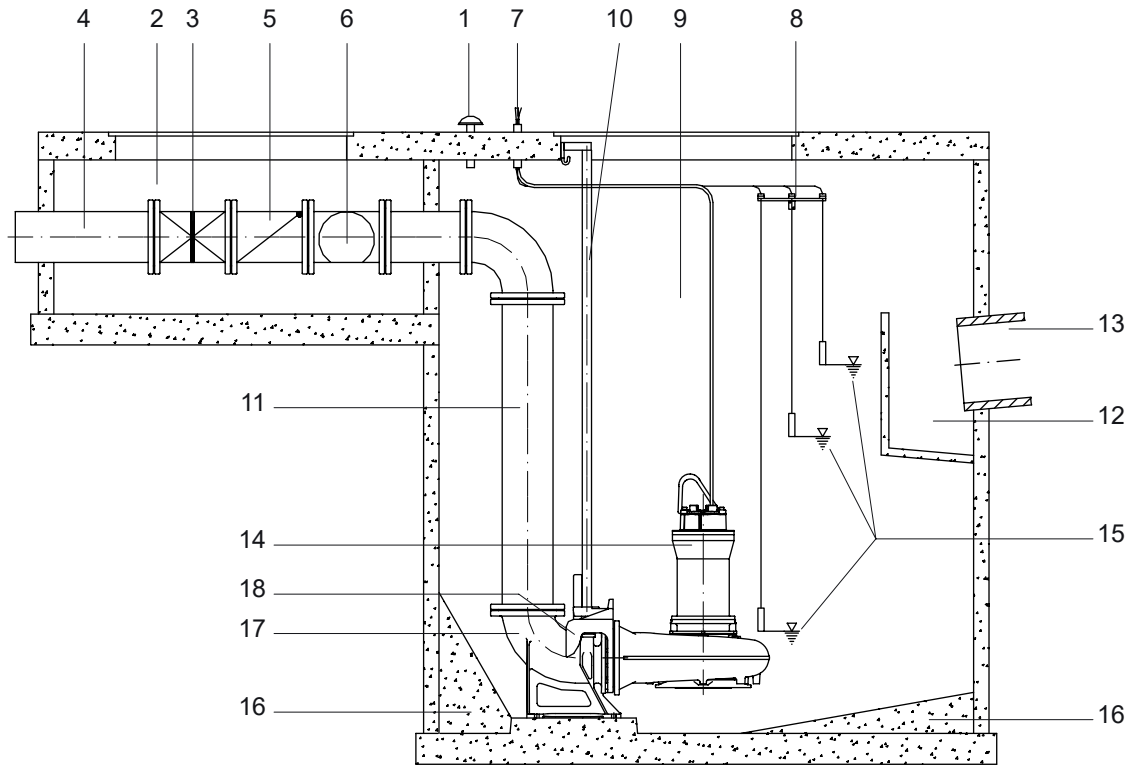

- 1 Venting
- 2 Valve chamber
- 3 Shut-off valve
- 4 Outflow line
- 5 Non-return valve
- 6 Fitting for valve removal
- 7 Cable duct
- 8 Bracket for float switches
- 9 Collection sump
- 10 Guide tube
- 11 Discharge line
- 12 Inflow chamber with impact wall
- 13 Inflow line
- 14 Sulzer submersible sewage pump
- 15 Automatic level control
- 16 Concrete benching
- 17 Pedestal
- 18 Bracket

<b>!</b>	<b>NOTE</b>
	The dimensional sheets and foundation plans for each type of installation are supplied either with the planning documents or your order confirmation.

<b>!</b>	<b>ATTENTION</b>
	The power cables should be handled carefully during installation and removal of the pumps in order to avoid damage to the insulation. Ensure that the connection cables are lifted out simultaneously when lifting the pump out of the concrete sump or steel discharge pipe with the hoist .

### 9.2.1.1. Lowering the pump on the guide rail

#### About this task

Submersible sewage pumps should be installed in accordance with the figure below.

**Figure 8. Lowering the submersible pump**

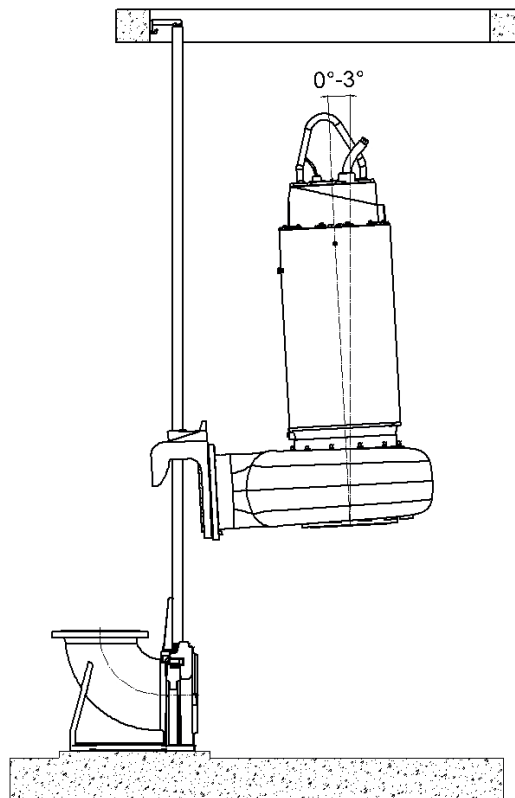

#### Procedure

1. Fit a hoist to the submersible sewage pump
2. Suspend the pump on the guide rail using the pedestal bracket on the pressure connection.
3. Carefully lower the pump vertically, or at a slight angle (max. 3°).
4. It couples automatically at the pedestal and seals the pressure connection at the flange face, by means of a seal and its own weight.

## 9.2.2. Dry installation

### Procedure

1. Fit a hoist to the submersible pump.
2. With the aid of a hoist, place the submersible pump into the prepared mounting frame and fasten.
3. Mount the suction and pressure nozzles on the pump housing.
4. If required, fit the vent line to the volute.
5. Open the gate valves on the suction and discharge side.

## 9.2.3. Fitting of pedestal bracket o-ring and guide piece

### About this task

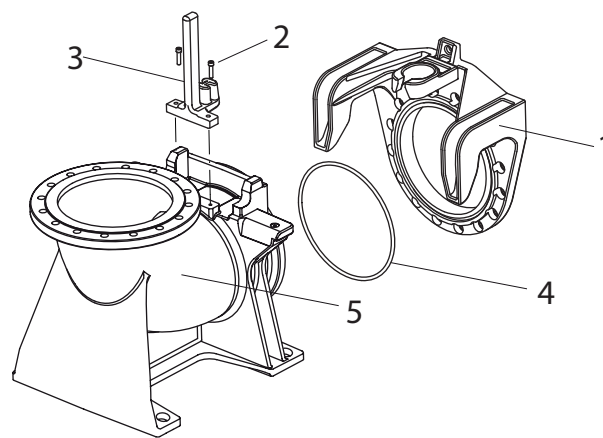

### Legend

1. Bracket
2. M12 screws
3. Guide piece
4. O-ring
5. Pedestal

### Procedure

1. Ensure that the o-ring and the groove in the bracket are clean and free of grease.
2. Evenly spread the instant adhesive 'LOCTITE type 454' on the o-ring (4) and on the base of the groove in the bracket (1) and insert o-ring immediately.



### ATTENTION

Ensure that adhesive does not come into contact with skin or eyes! Wear safety glasses and gloves!



### NOTE

The hardening time of the adhesive is only about 10 seconds!

3. Screw on the guide piece (3) as shown in the drawing.
4. Attach the guide piece to the pedestal (5) with the two M12 screws (2).
5. Tighten the screws with a torque of 56 Nm.

### 9.2.4. Tightening torque

Table 4.

Tightening torque for Sulzer stainless steel screws A4-70									
Thread	M6	M8	M10	M12	M16	M20	M24	M27	M30
Tightening torque	6.9	17 Nm	33 Nm	56 Nm	136 Nm	267 Nm	460 Nm	500 Nm	600 Nm

### 9.2.5. Fitting position of the Nord-Lock® securing washers

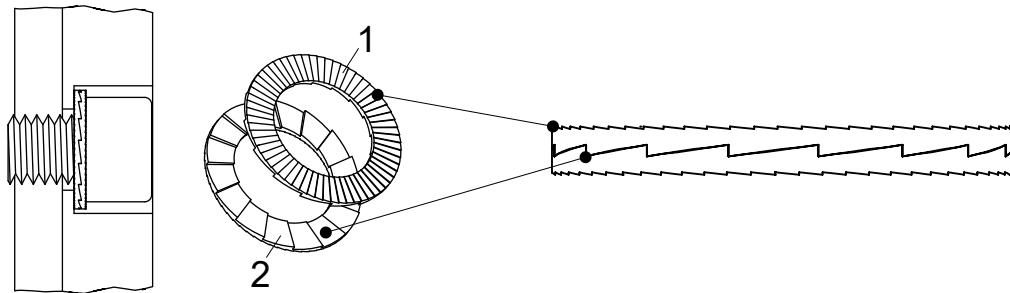

- 1 Outer side of the two securing washers
- 2 Inner side of the two securing washers

### 9.3. Installation - AFLX / VUPX

Figure 9. (A) Installation in a steel discharge pipe. (B) Installation in a concrete sump

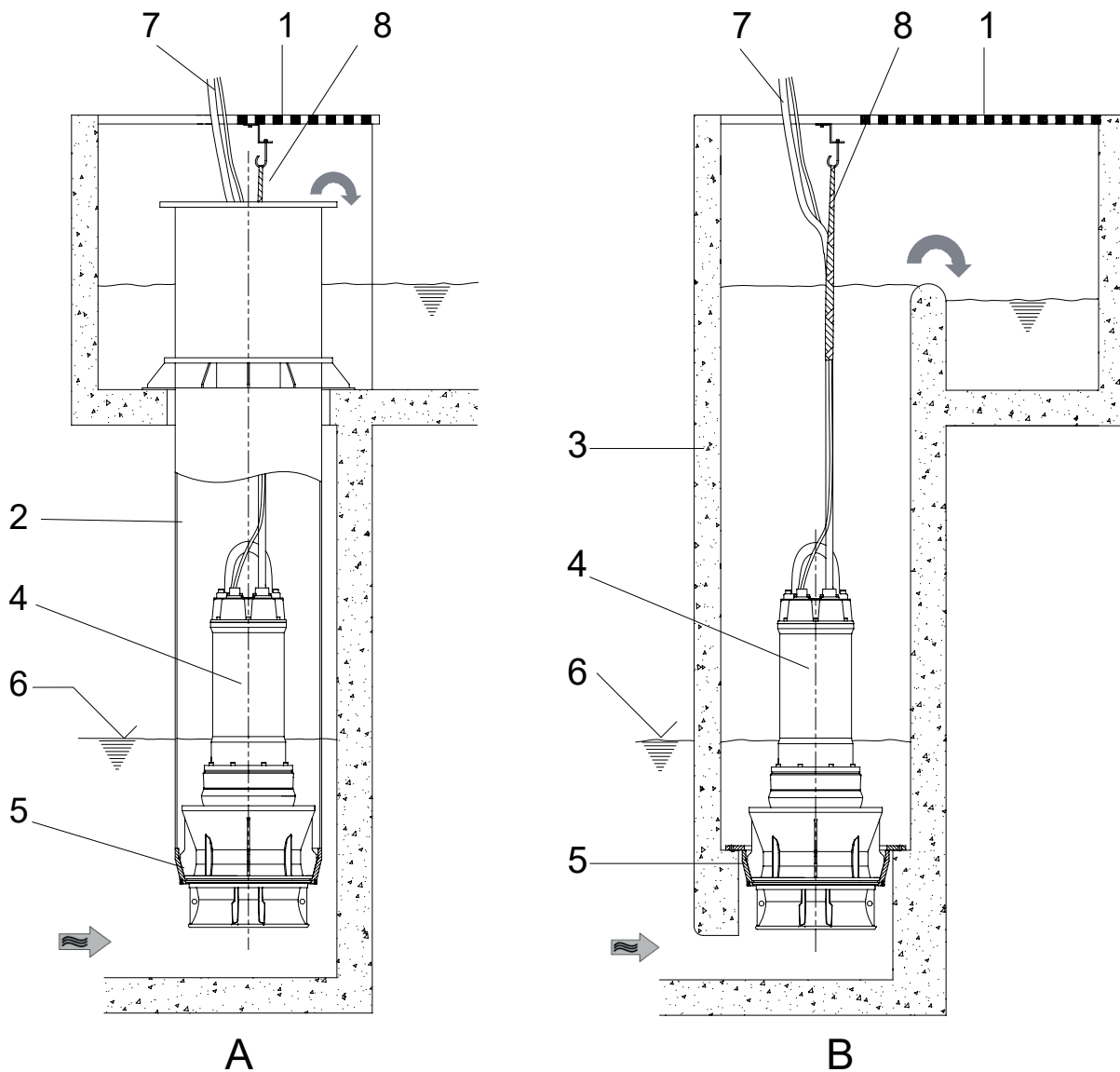

**Legend:**

- 1 Tank cover
- 2 Discharge (riser) pipe
- 3 Concrete sump
- 4 AFLX / VUPX submersible pump
- 5 Coupling ring
- 6 Minimum water level (see installation drawings)
- 7 Connection cable
- 8 Cable support (for fixing the power cable)

<b>!</b>	<b>ATTENTION</b>
	The power cables should be handled carefully during installation and removal of the pumps in order to avoid damage to the insulation.

<b>!</b>	<b>NOTE</b>
	Fit a hoist to the submersible pump.

The coupling ring required for installation of the AFLX/VUPX submersible pump must already be installed as shown in the figures above.

Before installation of the pump a suitable support (hook) for the chain, as well as an opening and suspension (cable sock) for the cable must be provided in the sump or riser pipe. Before or during the installation the motor connection cables should be fitted on site with suitable strain relief (e.g. cable socks). Particular care should be taken that the cable insulation is not crushed or damaged by the weight of the hanging cable especially in the area of the cable inlet.

<b>!</b>	<b>ATTENTION</b>
	When raising the submersible pump out of the concrete sump or the steel discharge pipe with the hoist ensure that the connection cables are lifted out simultaneously as the pump itself is being raised.

### 9.3.1. Lowering of the AFLX and VUPX submersible pump into the coupling ring

#### About this task

<b>!</b>	<b>ATTENTION</b>
	Before lowering the pump a direction of rotation check should be carried out.

#### Procedure

1. Draw the cable hose over the end of the connection cable.

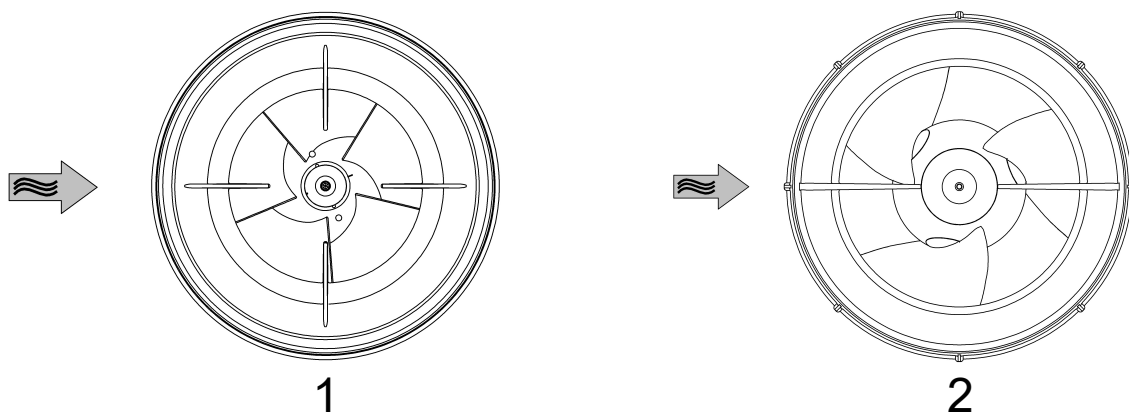

- 1 Bellmouth adjustment - AFLX
- 2 Bellmouth adjustment - VUPX

	<b>ATTENTION</b>
<p>The steel riser pipe, or concrete sump must be cleaned thoroughly (builder's rubble, etc.). To optimise the inflow and to reduce the noise level it is important that one pair of fins of the suction pipe are in line with the main flow direction of the inflow chamber. This must be observed when fitting the pump into a sump or into a steel discharge pipe.</p>	

2. Use lifting equipment to slowly lower the submersible mixed flow column/propeller pump into the shaft up to the coupling ring; feed in the motor connecting cable at the same time. The submersible mixed flow column/propeller pump centres itself automatically and leakage-free in the coupling ring.
3. Attach the lifting chain to the hook provided so that it cannot strike either the pump cable or the sump wall.
4. Tension the pump cable and fasten to the hook provided with the aid of the cable sock. Where a steel pressure pipe is used the connection cable should be brought through the connection cable inlet and sealed off in a watertight manner.

	<b>DANGER</b>
<p>The connection cable should only be tightened sufficiently so that no tension acts at the cable inlet in the head of the pump. The connection cable should not strike the chain or the sump wall.</p>	

5. If necessary, the steel riser pipe is sealed off in a watertight manner.

### 9.3.2. Bar spacing

A screen must be attached to the inlet of the **AFLX submersible mixed flow column pump** and the **VUPX submersible propeller pump**. The maximum bar spacing depends on the type of hydraulics fitted to the pump and can be obtained from the tables below.

Table 5.

Type of hydraulics	Clean water (Bar spacing in mm)	Run off water, river water, used water, rain water, pre-screened liquid, recirculation (Bar spacing in mm)
AFLX 0600/0700	≤ 40	≤ 20
AFLX 0800	≤ 60	≤ 30
AFLX 1200	≤ 100	≤ 50
If larger bar spacings are required, please contact Sulzer		

Type of hydraulics	Clean water (Bar spacing in mm)	Runoff water, river water, used water, rain water (Bar spacing in mm)	Pre-screened liquid, recirculation
VUPX 0400	≤ 30	≤ 25	≤ 6
VUPX 0500	≤ 40		
VUPX 0600	≤ 50		
VUPX 0800	≤ 60		
VUPX 1000	≤ 80		
VUPX 1200	≤ 80		
If larger bar spacings are required, please contact Sulzer			

	<b>ATTENTION</b>
	When setting the switching off level the minimum cover as given in the installation documents must be adhered to

## 10. Electrical connection

	<b>DANGER</b>
	<p><b>Dangerous voltage</b></p> <p>Before commissioning, an expert should check that one of the necessary electrical protective devices is available. Earthing, neutral, earth leakage circuit breakers, etc. must comply with the regulations of the local electricity supply authority and a qualified person should check that these are in perfect order.</p>

	<b>ATTENTION</b>
	The power supply system on site must comply with local regulations with regard to cross-sectional area and maximum voltage drop. The voltage stated on the nameplate of the pump must correspond to that of the mains.

Suitably rated means of disconnection shall be incorporated in the fixed wiring by the installer in accordance with applicable local National codes.

The power supply cable must be protected by an adequately dimensioned slow-blow fuse corresponding to the rated power of the unit.

	<b>DANGER</b>
	<p><b>Dangerous voltage</b></p> <p>The incoming power supply as well as the connection of the pump itself to the terminals on the control panel must comply with the circuit diagram of the control panel as well as the motor connection diagrams and must be carried out by a qualified person.</p>

All relevant safety regulations as well as general good technical practice must be complied with.

Submersible pumps used outdoors must be fitted with a power cable of at least 10 meter length. Other regulations may apply in different countries.

In all installations, the power supply to the pump must be via a residual current device (e.g. RCD, ELCB, RCBO etc.) with a rated residual operating current in accordance with local regulations. For installations not having a fixed residual current device the pump must be plugged into the power supply through a portable version of the device.

All three phase pumps must be installed with motor starting and overload protective devices in the fixed wiring by the installer. Such motor control and protective devices must comply with the requirements of IEC standard 60947-4-1. They must be rated for the motor that they control, and wired and set/adjusted according to the instructions provided by the manufacturer. In addition, the overload protective device that is responsive to the motor current shall be set / adjusted to 125% of the marked rated current.

	<b>DANGER</b>
	<p><b>Dangerous voltage</b></p> <p>Risk of electrical shock. Do not remove cord and strain relief and do not connect conduit to pump.</p>

	<b>NOTE</b>
	Please consult your electrician.



<b>!</b>	<b>ATTENTION</b>
	The unit should only be operated with the overload relay and thermal sensors/limiters connected.

## 10.1. Seal monitoring

The submersible pumps, depending on execution, are supplied as standard with one or more leakage sensors (DI) for seal monitoring. The leakage sensor carries out the seal monitoring function and signals the ingress of moisture into the motor by means of a special electronic device.

In order to integrate this seal monitoring function into the control panel of the unit it is necessary to fit a Sulzer leakage control module.

**Figure 10. Sulzer leakage control type CA 461**

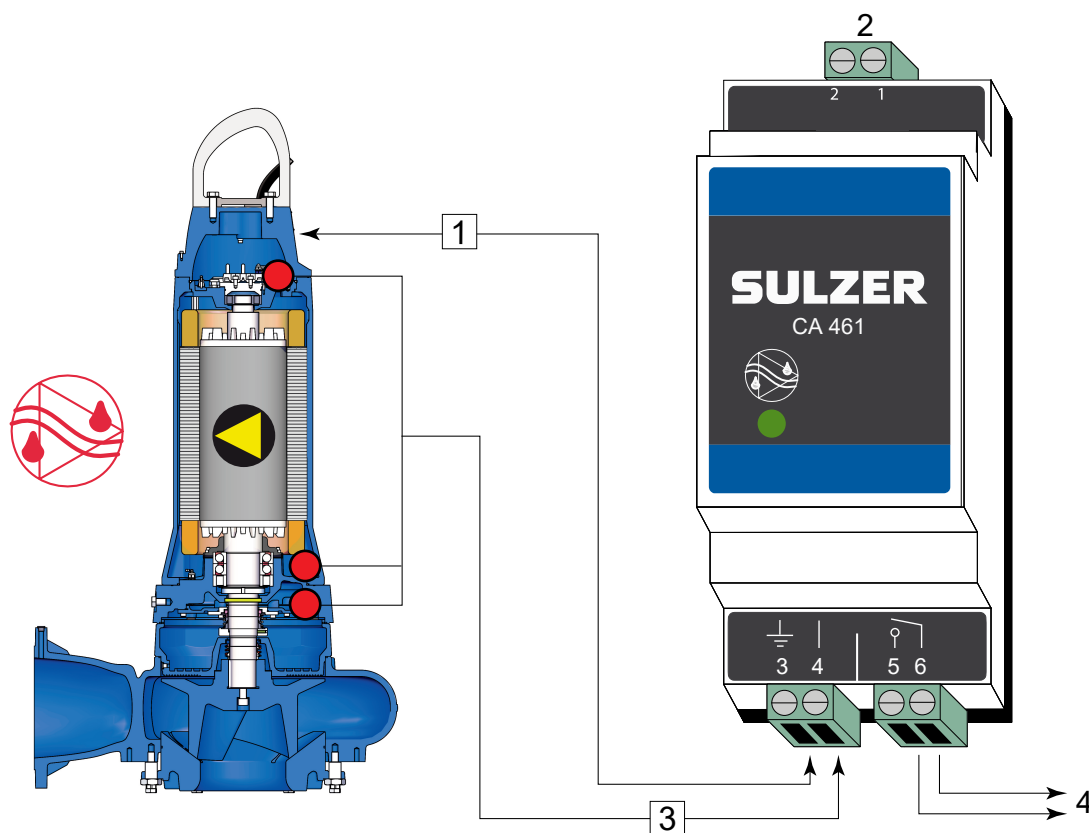

- 1 Connect terminal 3 to ground or housing of the pump.
- 2 Power supply
- 3 Leakage input
- 4 Output

### Electronic amplifier for 50/60 Hz

**110 - 230 V AC (CSA)** - Part No.: 16907010. **18 - 36 V DC (CSA)** - Part No.: 16907011

Multiple-input leakage control modules are also available. Please consult with your local Sulzer representative.

<b>!</b>	<b>ATTENTION</b>
	Maximum relay contact loading: 2 Ampere

	<b>NOTE</b>
	It is very important to note that with the connection example above it is not possible to identify which sensor/alarm is being activated. As an alternative Sulzer highly recommends to use a separate CA 461 module for each sensor/input, to allow not only identification but also to prompt to the appropriate response to the alarm category/severity

	<b>ATTENTION</b>
	If the leakage sensor (DI) is activated the unit must be immediately taken out of service. Please contact your Sulzer service center.

**Related references**

[Monitoring options](#) on page 31

### 10.3. Temperature monitoring - Stator

Thermal limiters protect the stator from overheating in the case of asymmetric phase loading or voltage, continuous dry running, or excessive temperatures in the medium itself. The stator is equipped with three bimetallic thermal limiters (optional PTC, PT100) which are connected in series.

### 10.4. Temperature monitoring - Bearings (Optional)

In the case of existing bearing monitoring, a bimetal temperature limiter is built into the bearing flanges of the standard version. This enables premature switching off of the submersible motor (e.g., due to wear-related increase in bearing temperature).

**Switching temperature:**

- Upper bearing = 140 °C / 284 °F
- Lower bearing = 130 °C / 269 °F

### 10.5. Temperature sensor

A continuous indication of the temperature in the stator and the bearings is not possible using bimetallic thermal limiters or thermistors. For this application it is necessary to fit thermal sensors of the type PT 100 with linear characteristics into the stator and bearing blocks. This type of resistor has a linear characteristic, i.e. the resistance rise is proportional to the temperature rise.

	<b>NOTE</b>
	Running the pump with the thermal and/or leakage sensors disconnected will invalidate related warranty claims.

	<b>ATTENTION</b>
	Thermistors must never be directly connected into the control or power system. They must always be connected to a suitable evaluation device.

The thermal monitoring circuit must be wired into the motor contactors in such a manner that a manual reset is required.

### 10.5.1. Temperature sensor bimetal

Figure 11. Curve showing operation principle of bimetallic temperature limiter

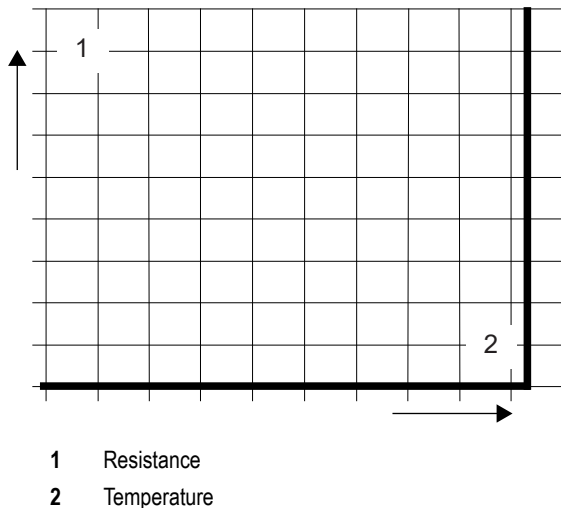



Table 6.

Application	Option
Function	Temperature switch using the bimetallic principle, which opens at a rated temperature
Switching	Taking care not to exceed the allowable switching current, these can be fitted directly into the control circuit

<b>Operating voltage AC</b>	100 V to 500 V ~
<b>Rated voltage AC</b>	250 V
<b>Rated current AC <math>\cos \varphi = 1,0</math></b>	2.5 A
<b>Rated current AC <math>\cos \varphi = 0,6</math></b>	1.6 A
<b>Max. switching current at <math>I_N</math></b>	5.0 A

ATTENTION	
	<p>The maximum switching ability of the thermal sensors is 5 A, the rated voltage 250 V. Explosion-proof motors which are connected to static frequency inverters must be fitted with thermistors. Activation must be by means of a thermistor protective relay device with PTB approval number.</p>

### 10.5.2. Temperature sensor PTC

Figure 12. Curve showing principle of operation of thermistor

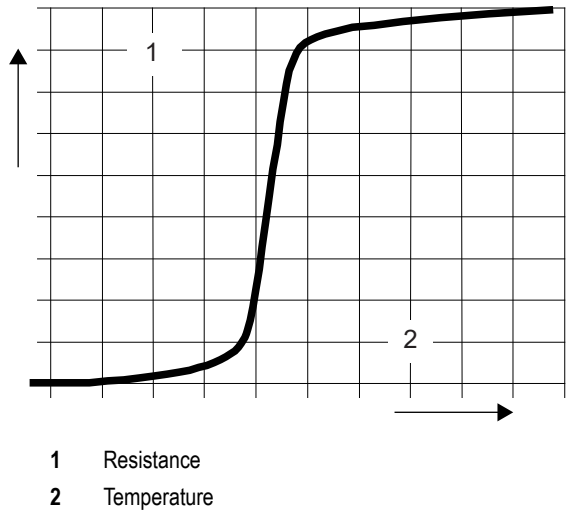
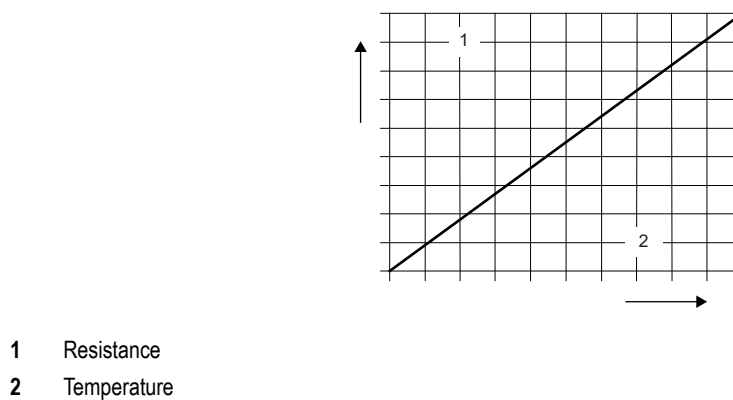

Table 7.

Application	Option
Function	Temperature dependent resistance (no switch) curve with stepwise behavior
Switching	Cannot be installed direct into the control circuit. Evaluation of the signal must be carried out by suitable electronic equipment

### 10.5.3. Temperature sensor PT 100

Figure 13. Curve showing principle of operation of PT 100



**Table 8.**

Application	Option (not for Ex)
Function	Function temperature dependent resistance (no switch). The linear curve allows continuous measurement and indication of the temperature
Switching	Cannot be installed direct into the control circuit. Evaluation of the signal must be carried out by suitable electronic equipment

## 10.6. Operation with variable frequency drive (VFD)

The stator design and the insulation grade of the motors from Sulzer means that they are suitable for usage with VFD, according to IEC 60034-25:2022 / NEMA 61800-2:2005. It is however essential that the following conditions are met:

- The guidelines for EMC (electromagnetic compatibility) are complied with.
- Explosion-proof motors must be equipped with thermistors (PTC temperature sensors) if operated in hazardous areas (ATEX Zone 1 and 2).
- Machines designated as Ex machines may never, without exception, be operated using a mains frequency that is greater than the maximum of 50 Hz or 60 Hz as indicated on the nameplate. Make sure that the rated current specified on the nameplate is not exceeded after starting the motors. The maximum number of starts according to the motor data sheet may not be exceeded.
- Machines that are not designated as Ex machines may only be operated using the mains frequency indicated on the nameplate. Greater frequencies can be used but only after consulting with and receiving permission from the Sulzer manufacturing plant.
- For operation of Ex-motors on VFD's, special requirements in relation to the tripping times of the thermo control elements must be observed.
- The lowest frequency must be set so that the minimum fluid velocity of 1 m/s is present in the volute.
- The maximum frequency must be set so that the rated power of the motor is not exceeded.

VFD's must be equipped with adequate filters when used in the critical zone. The filter chosen must be suitable for the VFD with regard to its rated voltage, wave frequency, rated current, and maximum output frequency. Ensure that the voltage characteristics (voltage peaks, dU/dt and rise time of the voltage spikes) at the motor terminal board is in accordance to IEC 60034-25:2022 / NEMA 61800-2:2005. This can be achieved using various types of VFD filters, depending on the specified voltage and cable length. Please contact your supplier for detailed information and the correct configuration.

## 10.7. Wiring diagrams

**Figure 14. (1) 50 Hz: Two power cables and one control cable. (2) 60 Hz: One power cable and one control cable.**

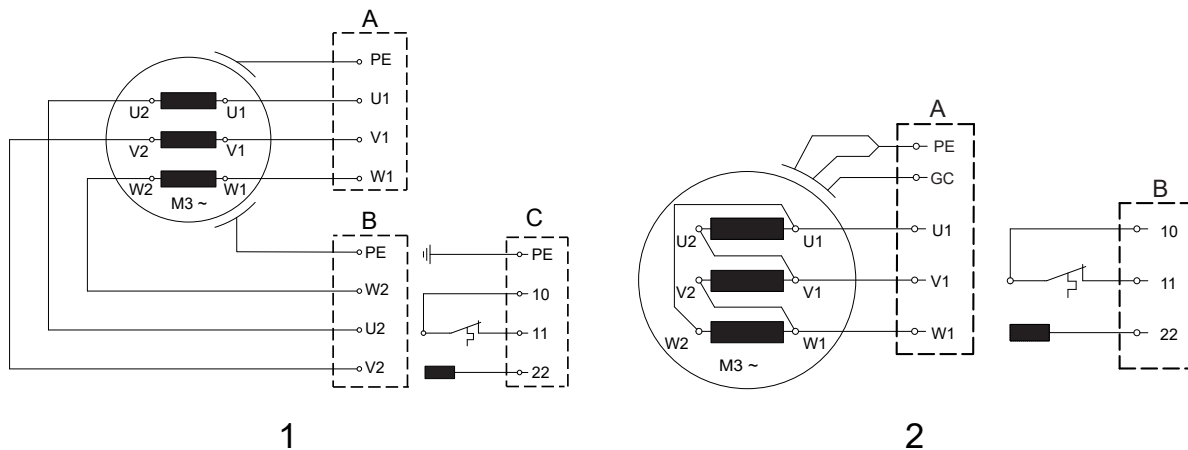

Figure 15. (3) 50 Hz Special versions: Two power cables and one control cable.

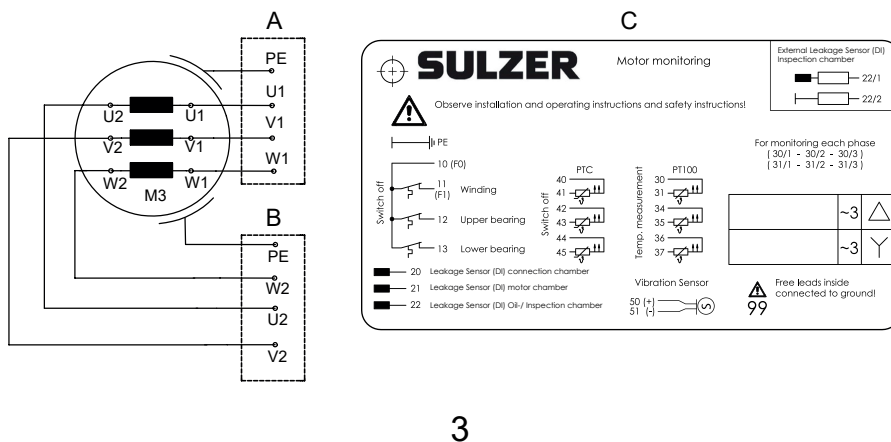

Figure 16. (4) 60 Hz: One power cable and one control cable - for optional motor monitoring features.

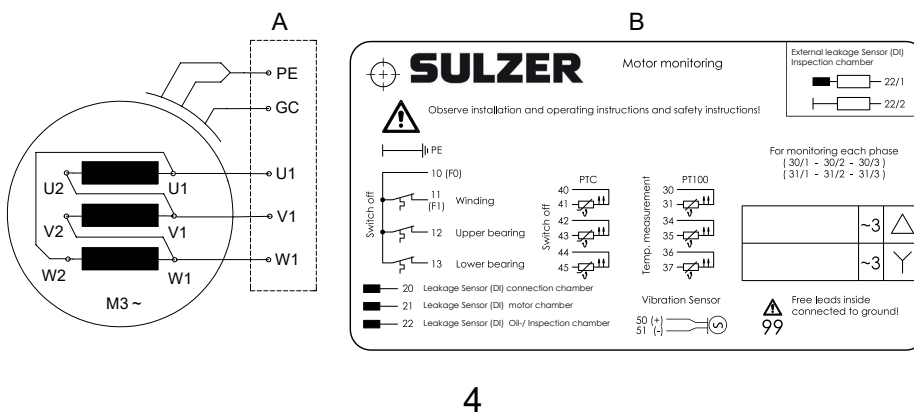

Table 9. Legend: 50 Hz / 60 Hz wiring diagrams

A = Cable 1	B = Cable 2	C = Cable 3
PE = Earth (Ground)	GC = Ground check	

<b>!</b>	<b>ATTENTION</b>
	The cable leads are routed out of the motor. No switching takes place in the motor! (Exception US-version). Any switching required (use of bridges) must be carried out in the control panel.
<b>!</b>	<b>NOTE</b>
	Information on the type of starting can be obtained from the nameplate of the pump.

### 10.7.1. Lead designations

**Table 10.**

Direct starting in star					
	L1	L2	L3	Join	
North America	T1 (U1)*	T2 (V1)*	T3 (W1)*		
Sulzer / Factory Standard	U1	V1	W1	U2 & V2 & W2	

**Table 11.**

Direct starting in delta					
	L1	L2	L3	Join	
North America	T1 (U1)*	T2 (V1)*	T3 (W1)*	-	
Sulzer / Factory Standard	U1; W2	V1; U2	W1; V2	-	

### 10.8. Monitoring options

**Table 12.**

Motors		PE3 50 Hz		PE4/PE5 50 Hz		PE6 50 Hz		PE3 60 Hz		PE4/PE5 60 Hz		PE6 60 Hz	
		Non-Ex	Ex	Non-Ex	Ex	Non-Ex	Ex	Non-Ex	Ex	Non-Ex	Ex	Non-Ex	Ex
Stator temperature	Bimetallic	●	●*	●	●*	●	●*	●	●*	●	●*	●	●*
	Thermistors (PTC)	○	○*	○	○*	○	○*	○	○*	○	○*	○	○*
	PT 100	-	-	○	○	○	○	-	-	○	○	○	○
Leakage sensor	Inspection chamber	-	-	●	○	●	○	-	●	●	●	●	●
	Motor chamber	●	●	○	●	●	●	●	-	○	○	●	●
	Connection chamber	-	-	○	○	●	●	-	-	○	○	●	●
Upper and lower bearing temperature	Bimetallic	-	-	○	○	●	●	-	-	○	○	●	●
	Thermistors (PTC)	-	-	○	○	○	○	-	-	○	○	○	○
	PT 100	-	-	○	○	○	○	-	-	○	○	○	○

*table continued*

Motors	PE3 50 Hz		PE4/PE5 50 Hz		PE6 50 Hz		PE3 60 Hz		PE4/PE5 60 Hz		PE6 60 Hz	
	Non-Ex	Ex	Non-Ex	Ex	Non-Ex	Ex	Non-Ex	Ex	Non-Ex	Ex	Non-Ex	Ex
● = Standard ○ = Option * Ex with VFD, monitoring via PTC												

### 10.9. Connection of the control circuit leads

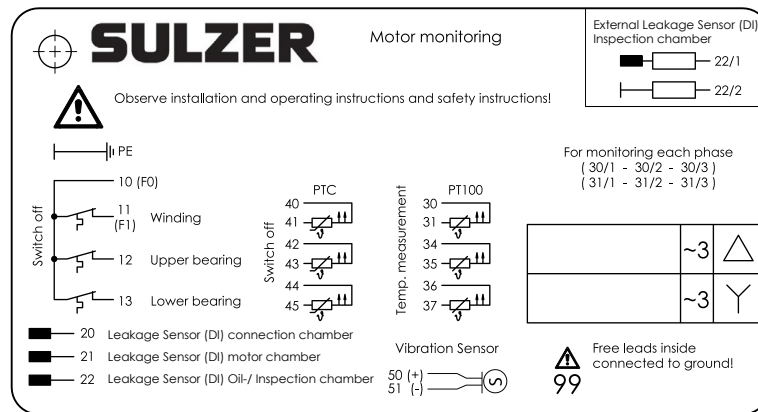

- 10 Common lead
- 11 Stator upper
- 12 Bearing upper
- 13 Bearing lower
- 20 Leakage sensor (DI) - Connection chamber
- 21 Leakage sensor (DI) - motor chamber
- 22 Leakage sensor (DI) - inspection chamber
- PE (Green/yellow)



## 10.10. Connecting the EMC cable in the control cabinet

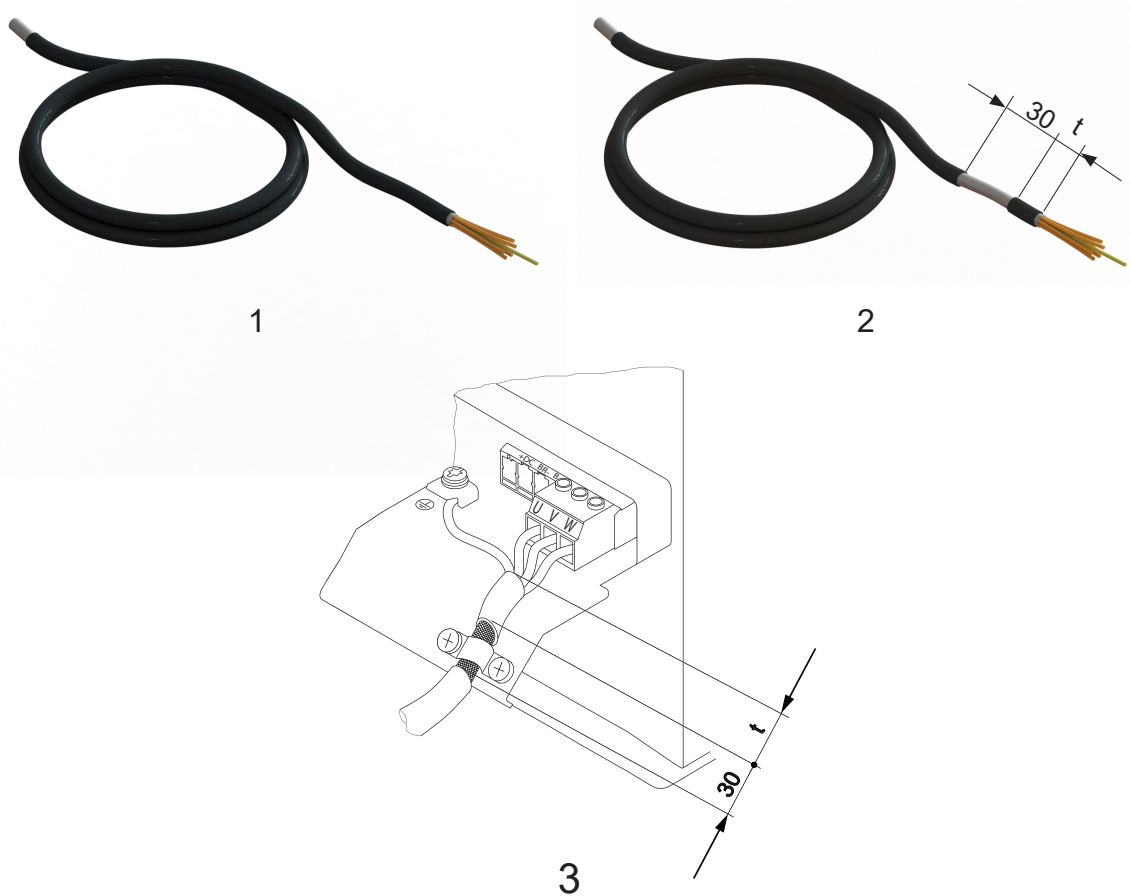

- 1 EMC cable in delivery condition. Cable is stripped!
- 2 Strip 30 mm from the EMC cable before connecting to the cable terminal board. Dimension "t" corresponds to the approximate gap from the fastening clip to the cable terminal.
- 3 Connecting the EMC cable in the control cabinet.

## 11. Commissioning

	<b>! CAUTION</b>
	All safety hints in other sections must be observed!
	<b>! DANGER</b>
	In explosive zones care must be taken that during switching on and operation of the pumps the pump section is filled with water (dry running) or alternatively is submerged or under water (wet well installation). Ensure in this case that the minimum submergence given in the data sheet is observed. Other types of operation e.g. snore operation or dry running are not allowed.



Before commissioning, the pump/pump station should be checked and a functional test carried out. Particular attention should be paid to the following:



- Have the electrical connections been carried out in accordance with regulations?
- Have the thermal sensors been connected?
- Is the seal monitoring device (where fitted) correctly installed?
- Is the motor overload switch correctly set?
- Does the unit sit correctly on the pedestal?
- Have the power and control circuit cables been correctly fitted?
- Was the sump cleaned out?
- Have the inflow and outflows of the pump station been cleaned and checked?
- Is the direction of rotation of the pump correct - even if run via an emergency generator?
- Are the level controls functioning correctly?
- Are the required gates valves (where fitted) open?
- Do the non-return valves (where fitted) function easily? (XFP)
- Has the volute been vented?
- Have the hydraulics been vented in the case of dry-installed pumps? (XFP)
- Have the steel riser pipe, or concrete sump be cleaned thoroughly (builder's rubble, etc.)? (AFLX / VUPX)

## 11.1. Direction of rotation

### 11.1.1. Checking direction of rotation

When three phase units are being commissioned for the first time, and also when used on a new site, the direction of rotation must be carefully checked by a qualified person.

	 <b>CAUTION</b>
	<p><b>The direction of rotation should only be altered by a qualified person.</b></p> <p>When checking the direction of rotation, the pump should be secured in such a manner that no danger to personnel is caused by the rotating impeller or by the resulting air flow. Do not place your hand into the hydraulic system!</p>

	 <b>CAUTION</b>
	<p>When checking the direction of rotation, or when starting the unit, pay attention to the <b>START REACTION</b>. This can be very powerful and cause the pump to jerk in the opposite direction to the direction of rotation.</p>

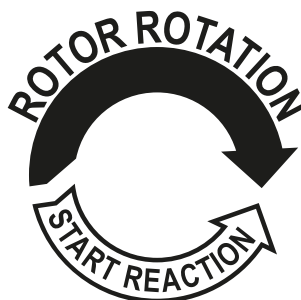

	<b>ATTENTION</b>
	<p>When viewed from above, the direction of rotation is correct if the impeller rotates in a clockwise manner.</p>

	<b>NOTE</b>
	<p>The start reaction is anti-clockwise.</p>

	<b>ATTENTION</b>
	If a number of pumps are connected to a single control panel then each unit must be individually checked.

	<b>ATTENTION</b>
	The mains supply to the control panel should have a clockwise rotation. If the leads are connected in accordance with the circuit diagram and lead designations, the direction of rotation will be correct.

### 11.1.2. Changing direction of rotation

	<b>CAUTION</b>
	<p><b>The direction of rotation should only be altered by a qualified person.</b></p> <p>If the direction of rotation is incorrect then this is altered by changing over two phases of the power supply cable in the control panel. The direction of rotation should then be rechecked.</p>

## 12. Maintenance and service

	<b>DANGER</b>
	<p><b>Dangerous voltage</b></p> <p>Before commencing any maintenance work the unit should be completely disconnected from the mains by a qualified person and care should be taken that it cannot be inadvertently switched back on.</p>

	<b>CAUTION</b>
	When carrying out any on-site service or maintenance work i.e. cleaning, venting, fluid inspection or changing, and adjustment of the bottom plate gap, the safety regulations covering work in enclosed areas of sewage installations as well as good general technical practices should be followed.

	<b>CAUTION</b>
	Repair work must only be carried out by qualified personnel approved by Sulzer.

	<b>WARNING</b>
	<p><b>Hot surface</b></p> <p>Under continuous running conditions the pump motor housing can become very hot. To prevent burn injury allow to cool down before handling.</p>

	<b>WARNING</b>
	<p><b>Hot liquid</b></p> <p>Coolant temperature can reach up to 60 °C under normal operating conditions.</p>

	<b>ATTENTION</b>
	The maintenance instructions given here are not designed for “do-it-yourself” repairs as special technical knowledge is required.

## 12.1. General maintenance instructions

Sulzer units are reliable quality products, each being subjected to careful final inspection. Lubricated-for-life ball bearings, together with monitoring devices, ensure optimum reliability provided that the unit has been connected and operated in accordance with the operating instructions.

Should, nevertheless, a malfunction occur, do not improvise but ask your Sulzer customer service department for assistance.

This applies particularly if the unit is continually switched off by the current overload in the control panel, by the thermal sensors/limiters of the thermo-control system, or by the seal monitoring system (DI).

Regular inspection and care is recommended to ensure a long service life. Service intervals vary for Sulzer units depending on installation and application. Contact your local Sulzer Service Center for more information. A maintenance contract with our Service Department will guarantee the best technical service.

The Sulzer service organisation would be pleased to advise you on any applications you may have and to assist you in solving any problems you may encounter.

When carrying out repairs, only original spare parts supplied by the manufacturer should be used. Sulzer warranty conditions are only valid provided repair work has been carried out in a Sulzer approved workshop, and original Sulzer spare parts have been used.

	<b>ATTENTION</b>
	Repair work on explosion-proof motors may only be carried out in authorized workshops by qualified personnel using original parts supplied by the manufacturer. Otherwise the Ex-approvals are no longer valid. Detailed technical information is available in the technical data sheet which can be downloaded from <a href="https://www.sulzer.com">https://www.sulzer.com</a>

## 12.2. Inspection intervals

	<b>ATTENTION</b>
	If the pumps have remained idle for more than twelve months then we recommend that you ask Sulzer or an approved distributor for advice.

**Before installation:** The covers giving moisture protection to the cables should only be removed immediately before actual installation of the pump. After the removal of the transport securing devices and before connecting up the pump electrically the motor shaft should be rotated a number of times by turning the impeller or propeller by hand.

**After installation:** If, after installation of the submersible pump it remains out of use for prolonged periods (for example in storm water holding tanks), then we recommend that the pump is run for a maximum of 1 minute every 3 months in order to check both its functioning and availability.

**Inspection chamber:** The oil in the inspection chamber should be checked every 12 months. Change the oil immediately if it is contaminated by water, or if an alarm indicates seal failure. If it happens again shortly after the oil has been changed, please contact your local Sulzer Service Representative.

**Motor chamber:** The motor chamber should be inspected every 12 months to ensure it is free from moisture.

## 12.3. Lubricants

	<b>ATTENTION</b>
	Only use products that are approved by the manufacturer!



	 <b>WARNING</b>
	Coolant temperature ≤ 60 °C

Figure 17. Symbols



**Legend**

**a = Fill with or drain oil**

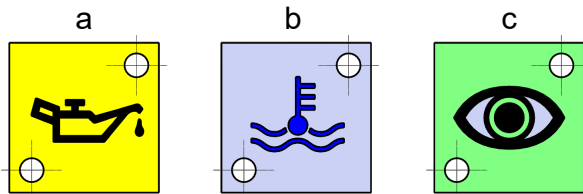
**b = Fill with or drain coolant**

**c = Visual inspection**

### 12.3.1. Lubricant changing - XFP with cooling jacket



**Initial filling at manufacture:**

Glycol Frostox WS (Part no.: 11030056) (TYFOROP Chemie GmbH)

**Alternative coolant released by Sulzer:**

Propylenglykol Code 27; (Houghton Deutschland GmbH); DOWCAL 20-G HEAT TRANSFER FLUID (Dow Deutschland GmbH & Co. OHG); DOWCAL brand of - The Dow Chemical Company.

	<b>NOTE</b>
	Data is only valid for coolant used in Ex works. Additional product information and safety data sheets are available on request.

	 <b>CAUTION</b>
	When dealing with Frostox WS, the general protective measures for chemicals and the information / hints in the safety data sheets must be observed!

#### 12.3.1.1. Oil / coolant changing XFP PE4 / PE5 / PE6

**Legend - XFP PE4 / PE5 / PE6**

1. Oil emptying/filling - inspection chamber (Pump should be in a horizontal position).
2. Inspection port - motor housing.
5. Coolant emptying.
6. Coolant filling.

**Figure 18. Oil / coolant filling and emptying XFP PE4**

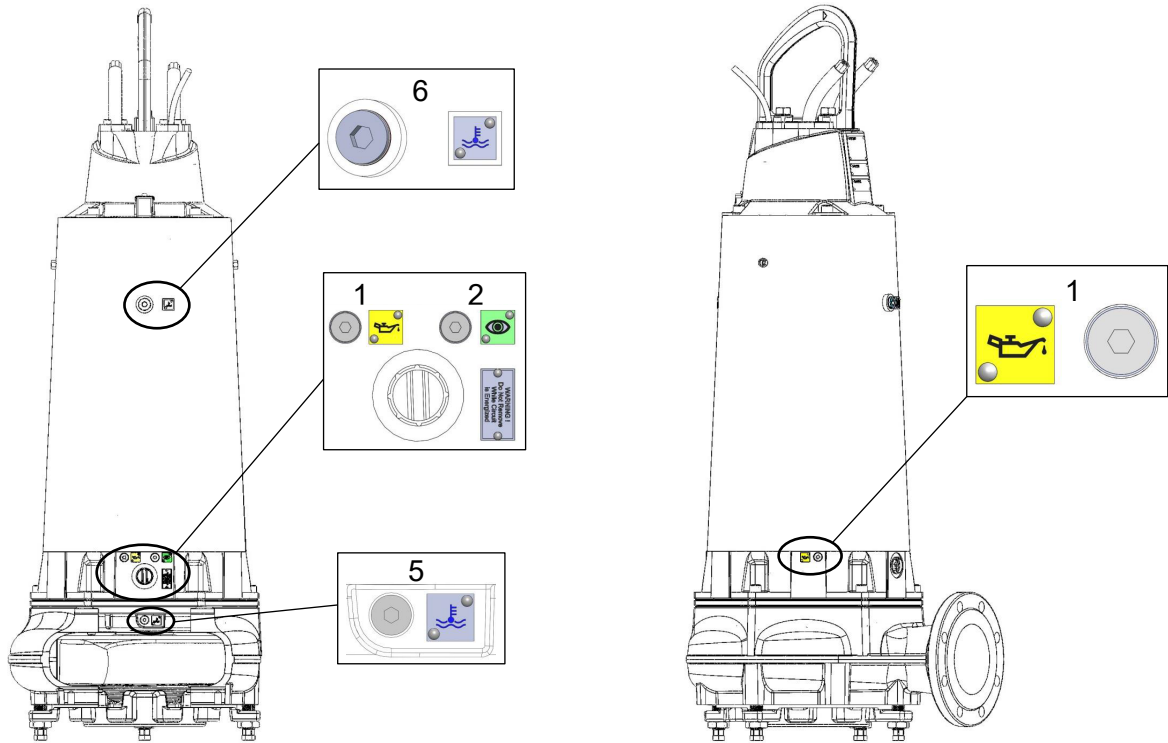

**Figure 19. Oil / coolant filling and emptying XFP PE5**

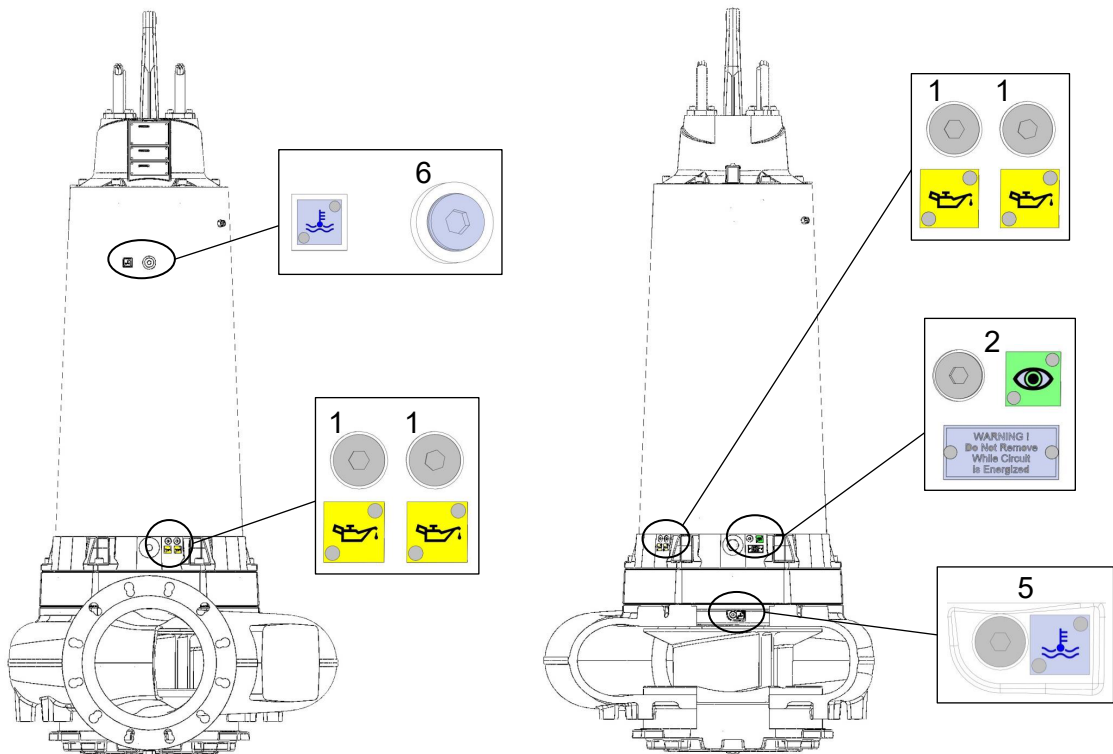

**Figure 20. Oil / coolant filling and emptying XFP PE6**

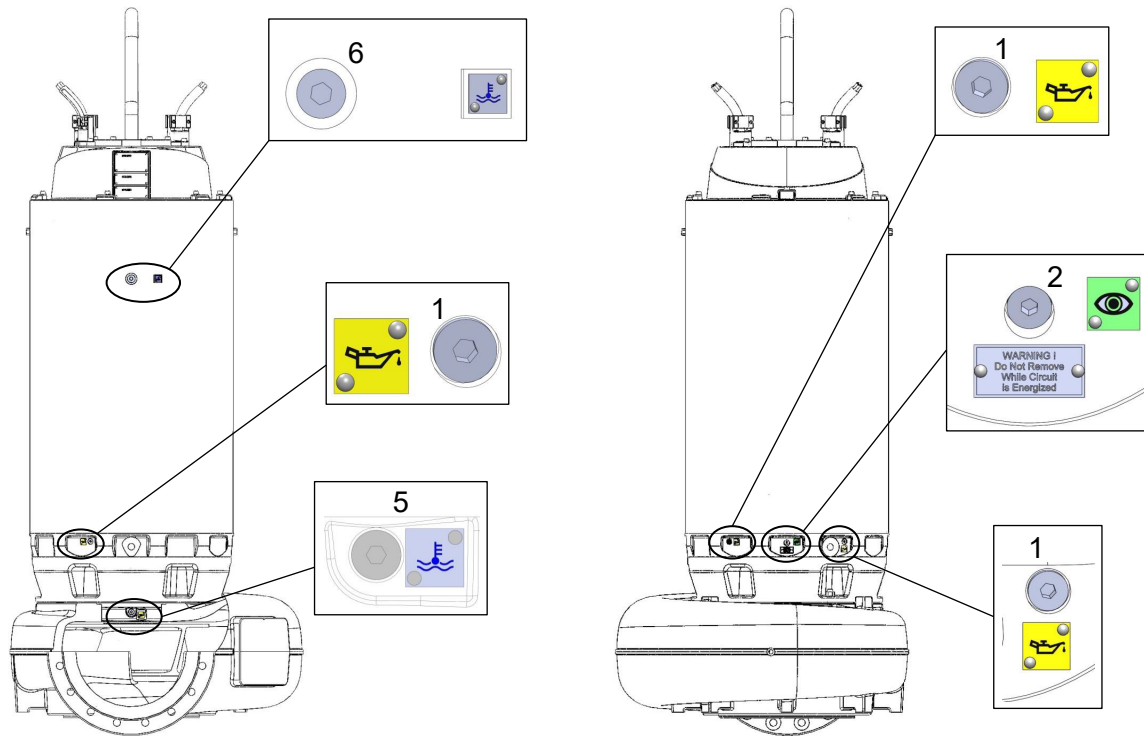

### Related references

[Oil filling quantities - Inspection chamber XFP / AFLX / VUPX](#) on page 44

[Coolant filling quantities - Seal chamber XFP PE4 - PE6](#) on page 46

## 12.3.2. Lubricant changing - XFP / AFLX / VUPX without cooling jacket

### 12.3.2.1. Oil changing XFP PE4 / PE5

#### Legend - XFP PE4 / PE5:

1. Oil emptying/filling - inspection chamber (pump should be in a horizontal position).
2. Inspection port - motor housing.
3. Oil draining - seal chamber.
4. Oil filling - seal chamber (pump should be in a horizontal position).

**Figure 21. Oil filling and emptying XFP PE4**

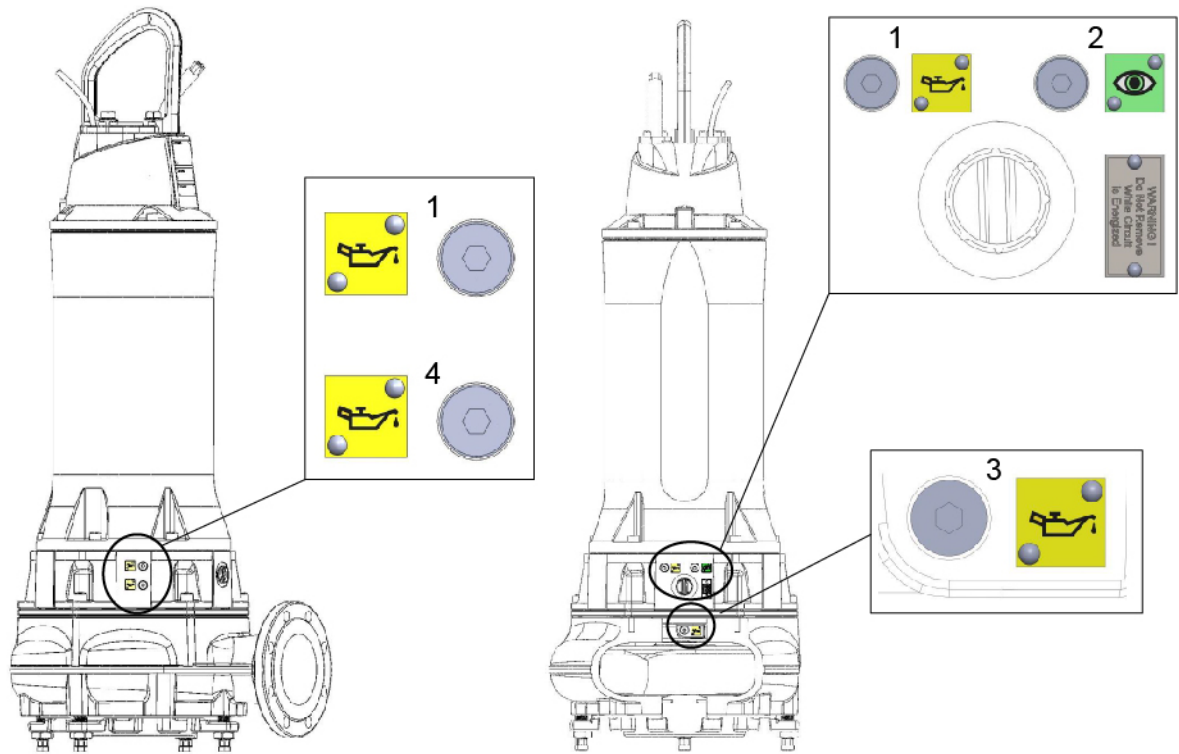



**Figure 22. Oil filling and emptying XFP PE5**

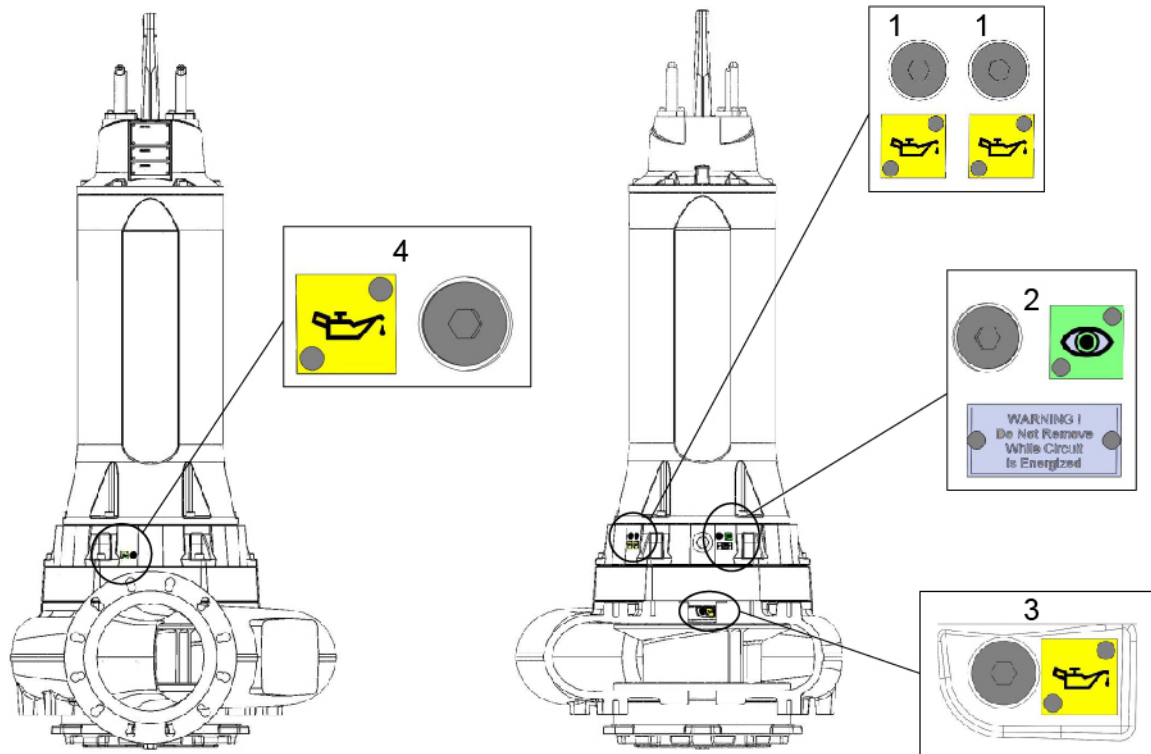

### Related references

[Oil filling quantities - Inspection chamber XFP / AFLX / VUPX](#) on page 44

[Oil filling quantities - Seal chamber XFP PE3 - PE5](#) on page 45

### 12.3.2.2. Oil changing AFLX and VUPX PE3 / PE4 / PE5 / PE6

#### Legend: AFLX and VUPX PE3 / PE4 / PE5 / PE6

1. Oil emptying/filling - inspection chamber (pump should be in a horizontal position).
2. Inspection port for motor housing.
3. Oil draining - seal chamber.
4. Oil filling - seal chamber (pump should be in a horizontal position).

**Figure 23. Oil filling and emptying AFLX / VUPX PE3**

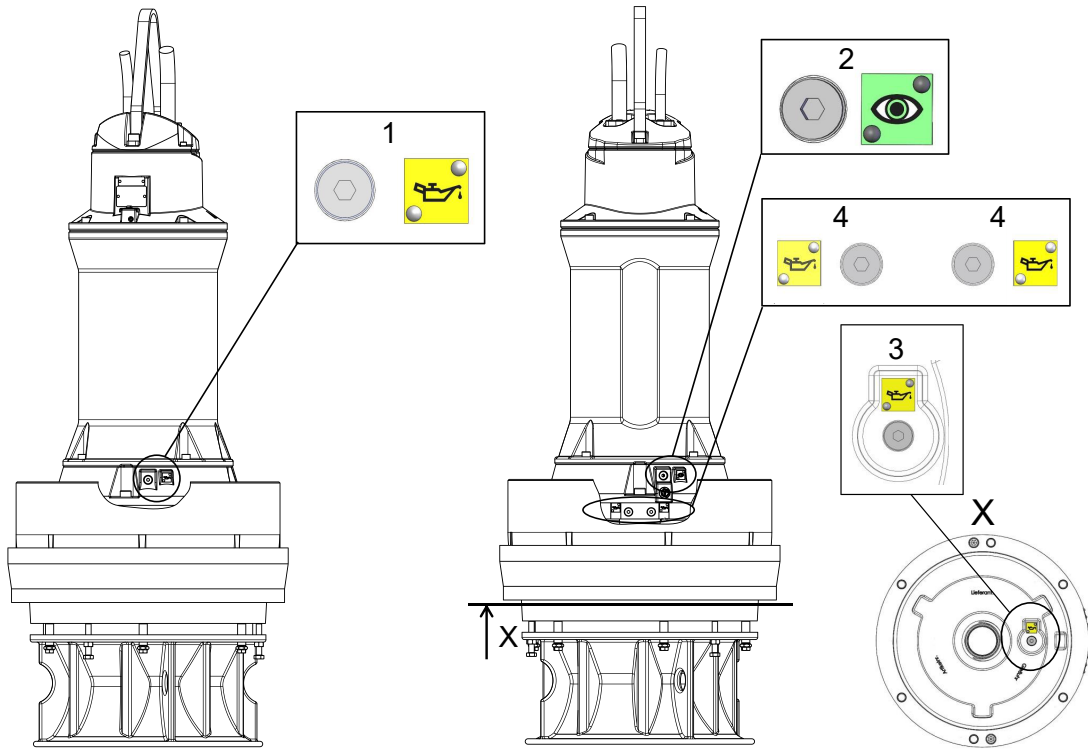

**Figure 24. Oil filling and emptying AFLX / VUPX PE4**

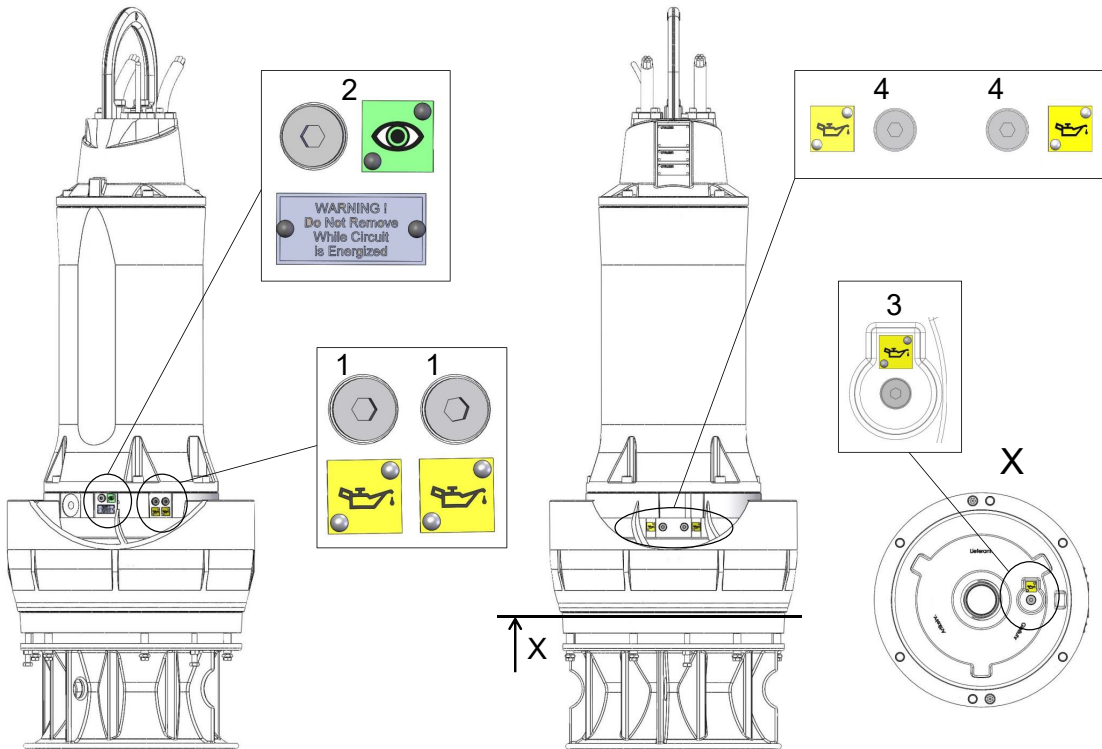

**Figure 25. Oil filling and emptying AFLX / VUPX PE5**

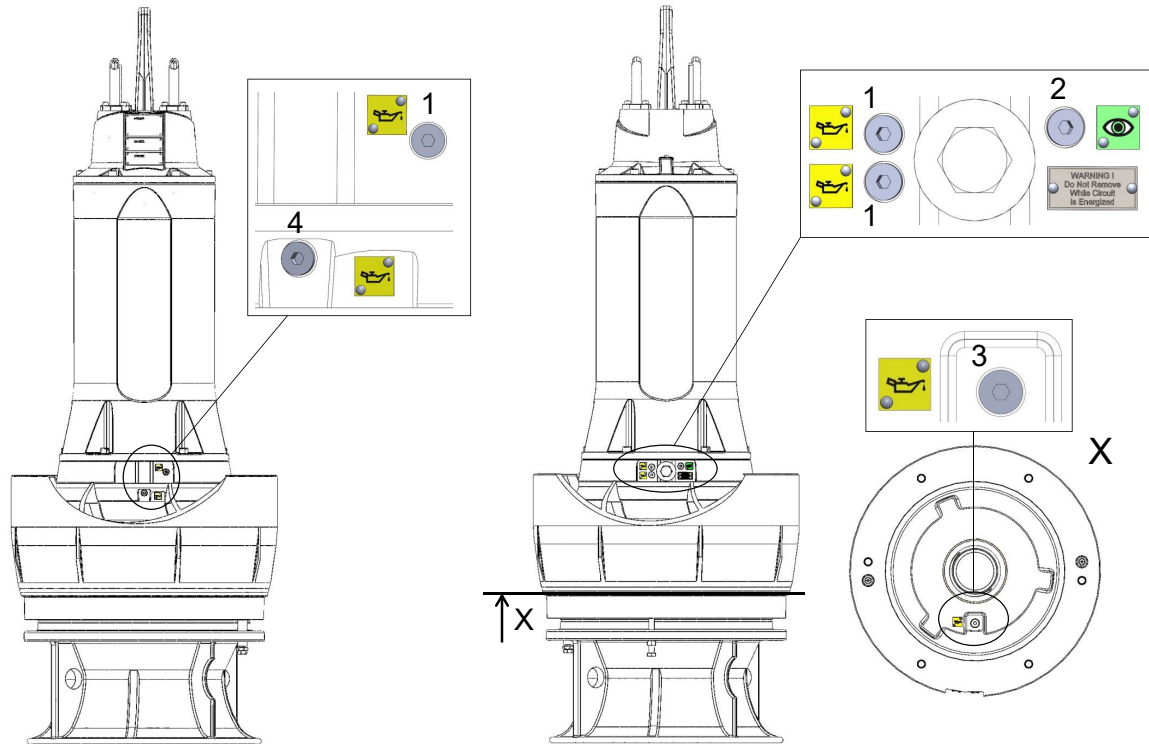

**Figure 26. Oil filling and emptying AFLX / VUPX PE6**

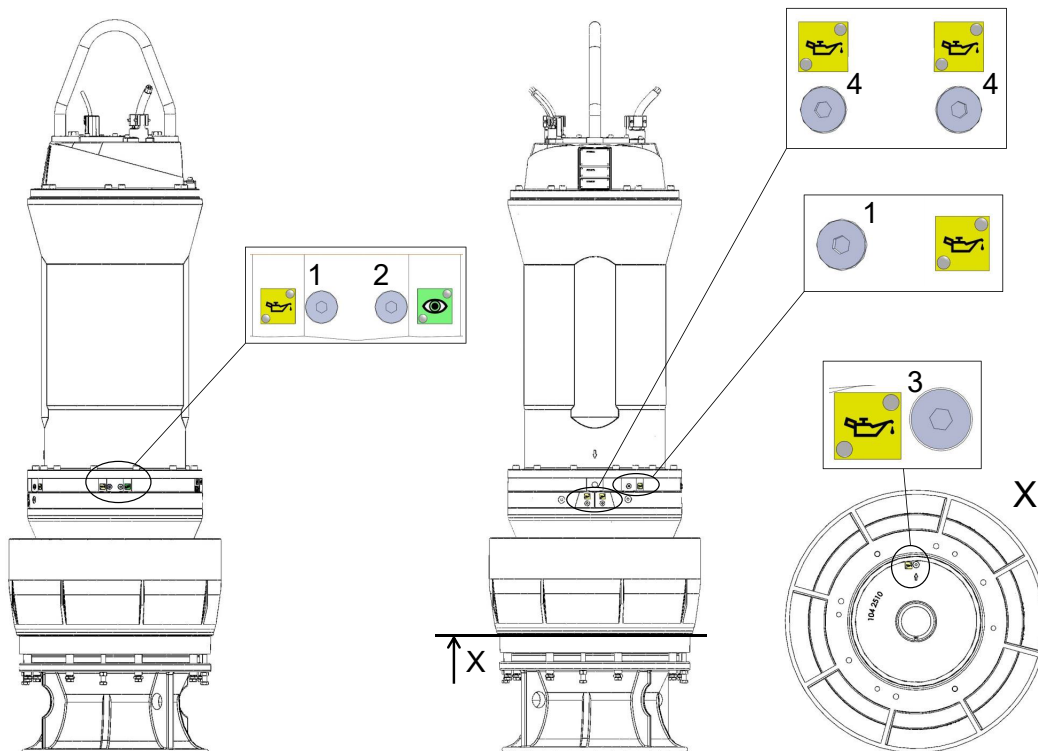

**Related references**

[Oil filling quantities - Inspection chamber XFP / AFLX / VUPX](#) on page 44

[Oil filling quantities - Seal chamber XFP PE3 - PE5](#) on page 45

[Oil filling quantities - Seal chamber AFLX / VUPX PE6](#) on page 45

**12.3.3. Oil and coolant quantities**

**12.3.3.1. Oil filling quantities - Inspection chamber XFP / AFLX / VUPX**

<b>!</b>	<b>NOTE</b>
	The oil quantity for the inspection chamber specified here is for versions with and without cooling jacket.

**Table 13. Filling volumes in liters**

Motor size	Cooling jacket	XFP	XFP-HA*	VUPX	AFLX
PE3	No	-	-	1.10	1.10
PE4	Yes	0.50	0.50	-	-
	No	2.50	-	2.50	2.50
PE5	Yes	0.42	-	-	-
	No	3.00	-	3.00	3.00

*table continued*

Motor size	Cooling jacket		XFP	XFP-HA*	VUPX	AFLX
PE6	Yes	Frame A	3.0	3.8	-	-
		Frame B and C	3.2	3.4		
	No		-	-	5.70	5.70

Hydraulic oil VG 32 HLP-D (part.no.: 11030021). \*horizontal

### 12.3.3.2. Oil filling quantities - Seal chamber XFP PE3 - PE5

Table 14. Filling volumes in liters

Motor size	XFP 501U	XFP J		XFP L	XFP M			VUPX			AFLX		
		CB - hydraulics	CH - hydraulics		CB - hydraulics	CB - hydraulics	CH - hydraulics	0400	0500 / 0600	0800	0600	0700	0800
PE3	-	-	-	-	-	-	-	7.5	7.5	-	7.1	7.5	-
PE4	-	8.0	11.5	-	-	-	-	3.7	3.5	-	3.7	3.6	-
PE5	27.0	16.0	16.0	22.0	22.0	20.0	-	3.8	5.0	-	3.8	3.8	-

Hydraulic oil VG 32 HLP-D (part.no.: 11030021)

### 12.3.3.3. Oil filling quantities - Seal chamber AFLX / VUPX PE6

Table 15. Filling volumes in liters.

Motor PE6 - Axial hydraulic	
Hydraulic	Filling quantity
VUPX 0600	6.5
VUPX 0800	15.0
VUPX 1000	24.0
AFLX 0800 / 1200	15.0

Hydraulic oil VG 32 HLP-D (part.no.: 11030021)

Table 16.

Motor PE6 - Axial hydraulic with gear unit		
Hydraulic	Filling quantity	Gear unit filling quantity
VUPX 1000G	4.5	52*
AFLX 1200G		
VUPX 1200G	5.3	

Hydraulic oil VG 32 HLP-D (part.no.: 11030021) \*Rivolta S.G.L 220 (part.no.:11030094)

### 12.3.3.4. Coolant filling quantities - Seal chamber XFP PE4 - PE6

**Table 17. XFP PE4 (Filling volumes in litres)**

Motor PE4		XFP 105J, 106J, 107J, 155J, 206J, 250J, 255J, 305J	
50 Hz	60 Hz	CB-hydraulics	CH-hydraulics
PE350/2**	PE430/2**	22	-
PE420/2**	PE540/2**	22	-
PE 220/4*	PE 250/4*	20	23.5
PE 300/4*	PE 350/4*	20	23.5
PE 370/4**	PE 430/4**	22	25.5
PE 450/4**	PE 520/4**	22	25.5
PE 185/6*	PE 210/6*	20	23.5
PE 220/6*	PE 250/6*	20	23.5
PE 300/6**	PE 350/6**	22	25.5
PE 370/6**	PE 430/6**	22	25.5
PE 150/8*	PE 170/8*	20	23.5
PE 185/8**	PE 210/8**	22	25.5
PE 220/8**	PE 250/8**	22	25.5
PE 300/8**	PE 350/8**	22	25.5
Motor size: * A; ** B. Part no.: 11030056			

**Table 18. XFP PE5 (Filling volumes in litres)**

Motor PE5		XFP 100J, 105J, 106J, 150J, 155J, 200J, 205J, 250J, 255J, 300J, 305J	XFP 205L, 255L	XFP 150M, 151M, 200M, 250M, 300M, 301M, 400M	XFP 205M, 305M, 306M, 351M, 356M, 405M	XFP 501U
50 Hz	60 Hz					
PE 550/4*	PE 630/4*	42.6		47.7		
PE 750/4*	PE 860/4*	42.6		47.7	48.9	
PE 900/4**	PE1040/4**	47.2		52.3	53.5	
PE1100/4**	PE1250/4**	47.2		52.3	53.5	
PE 450/6*	PE 520/6*	42.6		47.7	48.9	
PE 550/6**	PE 630/6**	47.2	52.3	52.3	53.5	
PE 750/6**	PE 860/6**	47.2	52.3	52.3	53.5	
PE 900/6**	PE1040/6**	47.2	52.3	52.3	53.5	58.6

*table continued*

Motor PE5		XFP 100J, 105J, 106J, 150J, 155J, 200J, 205J, 250J, 255J, 300J, 305J	XFP 205L, 255L	XFP 150M, 151M, 200M, 250M, 300M, 301M, 400M	XFP 205M, 305M, 306M, 351M, 356M, 405M	XFP 501U
50 Hz	60 Hz					
PE 370/8*	PE 430/8*			47.7	48.9	54
PE 450/8**	PE 520/8**			52.3	53.5	58.6
PE 550/8**	PE 630/8**			52.3	53.5	58.6
PE 750/8**	PE 860/8**			52.3	53.5	58.6
PE 300/10**	PE 350/10**				53.5	58.6
PE 370/10**	PE 430/10**					58.6
PE 450/10**	PE 520/10**					58.6
PE 550/10**	PE 630/10**					58.6

Motor size: \* A; \*\* B. Part no.: 11030056

Table 19. XFP PE6 (Filling volumes in litres)

Motor PE6		Radial hydraulics						
50 Hz	60 Hz	XFP 200M, 205M, 250M, 300M, 301M, 351M, 400M	XFP 305M, 306M, 356M, 405M	XFP 400R	XFP 500U	XFP 501U	XFP 600V	XFP 600X
PE 1320/4*	PE 1500/4*	112	112					
PE 1600/4*	PE 1850/4*	112	112					
PE 2000/4**	PE 2200/4**	126	126					
PE 2500/4**	PE 2800/4**	126	126					
PE 1100/6*	PE 1250/6*	112	112	118		118.5		
PE 1320/6*	PE 1500/6*	112	112	118		118.5		
PE 1600/6**	PE 1850/6**	126	126	132		132		
PE 2000/6***	PE 2200/6***	135	135	141		141		
PE 900/8*	PE 1040/8*	112	112	118		118.5		
PE 1100/8*	PE 1250/8*			118		118.5		
PE 1320/8*	PE 1500/8*			118	133	118.5		137.5
PE 750/10*	PE 860/10*					118.5		137.5
PE 900/10*	PE 1040/10*					118.5	123.5	137.5

table continued

Motor PE6		Radial hydraulics						
50 Hz	60 Hz	XFP 200M, 205M, 250M, 300M, 301M, 351M, 400M	XFP 305M, 306M, 356M, 405M	XFP 400R	XFP 500U	XFP 501U	XFP 600V	XFP 600X
PE 1100/10**	PE 1250/10**						138	152
PE 1320/10**	PE 1500/10**						138	152
	PE 860/12**						138	152
	PE 1040/12**						138	152
	PE 1250/12***						146.5	160.5
	PE 1500/12***						146.5	160.5
Motor size: * A; ** B; *** C. Part no.: 11030056								

### 12.3.4. Reference values for anti-freeze behaviour

Table 20.

Concentration (vol.%)		Antifreeze in °C
Frostox WS	Water	
10	90	to -3
20	80	to -8
30	70	to -13
40	60	to -23
50	50	to -35
60	40	to -52
33*	67*	to -16*
* Default		

### 12.4. Starting frequency of the motors

The allowable starting frequency per hour can be read from the table below (where not otherwise specified from the factory). However, the maximum number of starts according to the motor datasheet may not be exceeded.





**Table 21.**

Maximum starts per hour	At interval in minutes
15	4



	<b>ATTENTION</b>
	The allowable starting frequency for any starting devices should be obtained from the manufacturer of these devices.



## 12.5. Removal

	 <b>CAUTION</b>
	The safety hints in the previous sections must be observed!

### 12.5.1. Removal of the XFP submersible sewage pump from a wet sump

#### About this task

	 <b>DANGER</b>
	Before removal of the unit the motor connection cables at the control panel should be completely disconnected from the mains by a qualified person. Care should be taken that it cannot be inadvertently switched back on.

	 <b>DANGER</b>
	Before removal of units in hazardous areas the sump and surrounding area must be adequately vented to avoid the danger of a spark, causing an explosion!

#### Procedure

1. Fit a hoist to the pump.
2. Raise the submersible pump out of the sump with the hoist. While doing this, the connection cables should be simultaneously drawn out of the sump as the pump itself is being raised.
3. Place the submersible sewage pump vertically onto a firm surface and secure against tipping.

### 12.5.2. Removal of th XFP submersible sewage pump when dry-installed

#### Procedure

1. Close off the gate valves on the inlet and discharge sides.
2. Empty the volute and, if necessary, the discharge line.
3. If fitted, dismantle the venting line above the discharge.
4. Install lifting gear on the submersible pump.
5. Disconnect the suction inlet by opening the bolts on the bottom plate of the hydraulics (or at the pump housing).
6. Dismantle the pressure hose by loosening the screws on the pressure flange of the pump housing.
7. If necessary, remove the fastening bolts at the ground support ring and carefully lift the pump with the hoist.
8. Place the pump on an even, firm, flat surface.

### 12.5.3. Removal of the AFLX and VUPX submersible pump

#### Procedure

1. If present, the discharge pipe cover should be removed and the water-pressure-tight cable inlet opened.
2. Raise the submersible pump out of the concrete sump / steel discharge pipe with the hoist. While doing this, the connection cables should be drawn out as the pump itself is being raised.
3. Place the submersible pump with propeller housing vertically on a solid surface, taking care that it cannot tip over.

## 13. Company details

Address: Sulzer Pump Sweden AB Vadstena factory Box 170 SE-592 24 Vadstena, Sweden

Telephone: +46 10 1301500.

Website: [www.sulzer.com](http://www.sulzer.com)